

Phius 2021

PASSIVE BUILDING STANDARD CERTIFICATION GUIDEBOOK

Version 3.2 | July 2023



53 W. Jackson Blvd. Suite 1432
Chicago, IL 60604

(312) 561-4588
www.phius.org

Phius 2021 Passive Building Standard

Certification Guidebook

Version 3.2
July 2023

Phius
53 W. Jackson Blvd. Suite 1432
Chicago, IL 60604
(312) 561-4588
www.Phius.org

Contents

| | |
|--|-----------|
| 1. ABOUT PHIUS 2021 | 11 |
| 1.1 INTRODUCTION | 11 |
| 1.2 WHY CERTIFY? | 13 |
| 1.3 ABOUT THIS GUIDE | 14 |
| 1.4 THE PROJECT TEAM | 14 |
| 1.4.1 Team Member Roles & Responsibilities | 14 |
| 1.5 TYPES OF PROJECTS | 15 |
| 1.5.1 Single Family Residential Projects | 15 |
| 1.5.2 Multifamily Residential Projects | 15 |
| 1.5.3 Campus/Community Certification | 16 |
| 1.5.4 Commercial/Non-Residential Projects | 16 |
| 1.5.4.1 Dorms & Hotels/Motels | 17 |
| 1.5.5 Mixed-Use Projects | 17 |
| Phius Mixed-Use Approach | 17 |
| A) Whole Building Certification- One combined certification for Residential and Non-Residential | 19 |
| B) Whole Building Certification - Separate Residential and Non-Residential Certifications | 20 |
| C) Partial Building Certification - One combined certification for Residential and Non-Residential | 20 |
| D) Partial Building Certification - Separate Residential and Non-Residential Certifications | 20 |
| 1.5.6 Retrofit Projects | 22 |
| 1.5.7 Buildings with Seasonal Use | 23 |
| 1.6 PROGRAM VERSION ELIGIBILITY | 23 |
| 2. GENERAL NOTES/GUIDANCE | 24 |
| 2.1 GENERAL CHALLENGES ASSOCIATED WITH ENERGY EFFICIENT BUILDINGS | 24 |
| 2.2 "YELLOW FLAG" ITEMS | 24 |
| 3. BUILDING CERTIFICATION REQUIREMENTS | 25 |
| 3.1 Overview of Requirements | 26 |
| 3.1.1 Scope Requirements & Limitations | 26 |
| 3.1.2 Passive Conservation Requirements | 27 |
| 3.1.3 Airtightness Requirements | 28 |
| 3.1.4 Active Conservation Requirements | 28 |
| 3.1.4.1 Source Energy Limits | 30 |
| 3.1.4.2 Lighting, Appliance, & Equipment Efficiencies | 31 |
| 3.2 RENEWABLE ENERGY REQUIREMENTS | 31 |

| | | |
|-----------|--|-----------|
| 3.3 | MOISTURE DESIGN CRITERIA FOR ASSEMBLIES AND DETAILS | 31 |
| 3.3.1 | Opaque Assembly Moisture Design Requirements | 31 |
| 3.3.2 | Fenestration Moisture Design Requirements | 31 |
| 3.3.3 | Thermally Bridged Construction Detail Requirements | 32 |
| 3.4 | WINDOW COMFORT REQUIREMENTS | 32 |
| 3.5 | MANDATORY DESIGN REQUIREMENTS | 32 |
| 3.5.1 | Building Envelope | 33 |
| 3.5.2 | Ventilation | 34 |
| 3.5.2.1 | Balanced Ventilation | 34 |
| 3.5.2.2 | Ventilator Defrost | 35 |
| 3.5.2.3 | Quality Assurance Workbook Requirements | 35 |
| 3.5.3 | Heating, Cooling & Domestic Hot Water | 36 |
| 3.5.4 | Lights, Appliances, & Renewables | 37 |
| 3.5.5 | Water Management and Indoor Air Quality | |
| | Requirements outlined in the prerequisite program documents noted below apply to all Phius projects. | 38 |
| 3.5.6 | Electric Vehicle (EV) Charging Infrastructure | 39 |
| 3.5.7 | Combustion Equipment & Fireplaces | 39 |
| 3.5.3.1 | Fossil-Fueled Combustion Equipment | 39 |
| 3.5.3.2 | Fireplaces | 40 |
| 3.5.3.3 | Electrification Readiness | 40 |
| 3.6 | MANDATORY ON-SITE REQUIREMENTS AND RATER/VERIFIER INFORMATION | 40 |
| 3.6.0 | Personnel Required | 40 |
| 3.6.1 | Residential | 41 |
| 3.6.1.1 | Co-Requisite Program Requirements | 41 |
| 3.6.1.2 | Residential Exceptions | 41 |
| 3.6.2 | Non-Residential | 42 |
| 3.6.2.1 | Co-Requisite Program Requirements | 42 |
| 3.6.3 | Phius Certified Rater/Verifier Manual | 43 |
| 3.6.4 | Contractor Declaration | 43 |
| 4. | PROCESS | 46 |
| 4.0.1 | Phase 0: Project Feasibility Study (Optional) | 46 |
| 4.0.2 | Phase 1: Paperwork | 46 |
| 4.0.3 | Milestone 1: Project Registered | 46 |
| 4.0.4 | Phase 2: Design | 46 |
| 4.0.5 | Milestone 2: Design Certification | 47 |
| 4.0.6 | Phase 3: Construction | 47 |
| 4.0.7 | Milestone 3: Final Certification | 48 |
| 4.0.8 | Incentives | 48 |

| | |
|--|-----------|
| 4.1 GENERAL TIPS DURING THE PROCESS | 49 |
| 4.1.1 Review Timeline | 49 |
| 4.2 PHius PORTAL ACCESS & SUBMITTING A PROJECT | 50 |
| 4.3 DROPBOX INSTRUCTIONS AND TIPS | 51 |
| 4.4 REQUIRED SUBMISSION DOCUMENTATION | 51 |
| 4.4.0 Compliance Tool | 52 |
| 4.4.1 Construction Drawings | 52 |
| 4.4.1.1 Ventilation Calculations | 54 |
| 4.4.1.2 Site Plan | 54 |
| 4.4.1.3 Site Shading | 54 |
| 4.4.1.4 Interior Conditioned Floor Area (iCFA) | 54 |
| 4.4.2 Technical Specifications | 55 |
| 4.4.3 Pressure Test Verification | 55 |
| 4.4.4 Ventilation Commissioning | 56 |
| 4.4.5 Declaration of the Construction Supervisor | 56 |
| 4.4.6 Photograph Documentation | 56 |
| 4.4.7 Additional Documentation | 56 |
| 4.4.8 QA/QC Reports | 56 |
| 4.5 PHius CERTIFICATION FEEDBACK DOCUMENT | 56 |
| 4.6 Certified Project Database Listing | 57 |
| 4.6.1 Editing Your Listing | 57 |
| 4.6.2 Adding Photos | 57 |
| 5. PHius PROJECT CERTIFICATION FEE SCHEDULE | 57 |
| 5.1 PERFORMANCE PATH CERTIFICATION FEE | 57 |
| 5.1.1 Discounts | 58 |
| 5.2 PRESCRIPTIVE PATH CERTIFICATION FEE | 58 |
| 5.3 EXPEDITE FEES | 58 |
| 5.4 ADDITIONAL CONSULTING | 58 |
| 5.4.1 Red-Flag Review | 58 |
| 5.4.2 Feasibility Study Fee | 59 |
| 5.5 CERTIFICATION PLAQUE | 60 |
| 6. WUFI® PASSIVE ENERGY MODELING PROTOCOL | 60 |
| 6.1 GETTING STARTED | 60 |
| 6.1.1 Accepted Modeling Software | 60 |
| 6.1.1.1 General Recommended WUFI Passive Settings | 61 |
| 6.1.1.2 WUFI Passive Online Tutorials | 61 |
| 6.1.1.3 Project File Versions | 61 |
| 6.1.1.4 Dynamic modeling in WUFIplus | 61 |

| | |
|--|----|
| 6.1.2 Climate Data | 62 |
| 6.1.3 Energy Model Defaults | 62 |
| 6.1.4 Energy Model Inputs Requiring Additional Documentation | 62 |
| 6.1.5 External Calculators & Protocol Documents | 63 |
| 6.1.6 WUFI Passive Cases | 63 |
| 6.1.7 Using SketchUp with WUFI Passive | 63 |
| 6.2 LOCALIZATION/CLIMATE | 63 |
| 6.2.1 Localization | 63 |
| 6.2.1.1 Entering climate data into WUFI Passive Free | 64 |
| 6.2.2 Space Conditioning Target Data | 65 |
| 6.2.3 Source Energy/CO2-Factor | 66 |
| 6.3 PH CASE | 66 |
| 6.3.1 PH Case - General | 66 |
| 6.3.1.1 Occupancy and Internal Heat Gains | 66 |
| 6.3.1.2 Non-permanent occupants in multifamily buildings: Visitors and Workers | 67 |
| 6.3.1.3 Number of Units and Floors | 67 |
| 6.3.2 PH Case - Additional Data | 67 |
| 6.3.3 PH Case - Foundation Interface | 69 |
| 6.4 ZONE 1 | 70 |
| 6.4.1 Visualized Volume | 70 |
| 6.4.2 Gross Volume | 70 |
| 6.4.3 Net Volume | 70 |
| 6.4.4 Interior Conditioned Floor Area (iCFA) | 70 |
| 6.4.5 Specific Heat Capacity/Thermal Mass | 70 |
| 6.5 VISUALIZED COMPONENTS | 71 |
| 6.5.1 Wall Components | 71 |
| 6.5.2 Window Components | 71 |
| 6.5.3 Solar Protection/Shading | 73 |
| 6.5.3.1 Reveal Shading | 73 |
| 6.5.3.2 Shading Devices | 74 |
| 6.5.3.3 Overhangs | 74 |
| 6.5.3.4 Mulled Windows and Divided Lites | 75 |
| 6.5.3.5 WUFI Mean Month Shading Factors | 76 |
| 6.6 INTERNAL LOADS/OCCUPANCY | 77 |
| 6.6.1 Residential | 77 |
| 6.6.1.1 Calculation Methods | 77 |
| 6.6.1.2 Devices/Appliances | 77 |
| 6.6.1.3 Lighting and Miscellaneous Loads | 80 |

| | |
|---|------------|
| 6.6.2 Non-Residential | 81 |
| 6.6.2.1 Occupancy | 82 |
| 6.6.2.2 Office Equipment | 82 |
| 6.6.2.3 Kitchen Equipment | 83 |
| 6.6.2.4 Lighting | 84 |
| 6.6.2.5 Process Loads | 85 |
| 6.7 VENTILATION/ROOMS | 85 |
| 6.7.1 Utilization Pattern | 85 |
| 6.7.2 Rooms Ventilation | 86 |
| 6.7.3 Summer Ventilation | 87 |
| 6.7.4 Exhaust Ventilation | 88 |
| 6.8 THERMAL BRIDGES | 90 |
| 6.9 ATTACHED ZONES & REMAINING ELEMENTS | 91 |
| 6.9.1 Attached Zones | 91 |
| 6.9.2 Remaining Elements | 91 |
| 6.10 SYSTEMS | 92 |
| 6.10.1 Hydronic Heating Distribution | 92 |
| 6.10.2 Domestic Hot Water (DHW) Distribution | 93 |
| 6.10.2.1 Circulation Pipes | 93 |
| 6.10.2.2 Individual Pipes – Calculation Methods | 94 |
| 6.10.2.3 Individual Pipes – Steps for ‘Hot Water Piping Calculator’ | 95 |
| PATH A: No Recirculation | 95 |
| PATH B: On-Demand Recirculation | 97 |
| PATH C: Time-based or Continuous Recirculation | 99 |
| 6.10.2.4 Distribution Pipe Materials and Sizes | 99 |
| 6.10.3 Cooling | 99 |
| 6.10.4 Ventilation Distribution | 100 |
| 6.10.5 Auxiliary Energy | 100 |
| 6.10.6 Heating Devices | 101 |
| 6.10.7 Domestic Hot Water Devices | 103 |
| 6.10.8 Mechanical Ventilation Devices | 105 |
| 6.10.9 Renewable Energy Systems | 107 |
| 6.10.10 Drain Water Heat Recovery | 108 |
| 6.10.11 Electric Vehicle Charging | 109 |
| 6.11 WUFI PASSIVE REPORTS | 109 |
| 7. MONITORING | 109 |
| 7.1 MONITORING PROTOCOL | 110 |
| 7.2 MONITORING YOUR PROJECT | 110 |

| | |
|--|------------|
| 8. ADDITIONAL CERTIFICATION BADGES | 110 |
| 8.1 SUPPLY AIR HEATING AND COOLING SUFFICIENT | 110 |
| APPENDIX A – RENEWABLE ENERGY | 111 |
| A-1 RENEWABLE ENERGY SYSTEMS | 111 |
| A-2 ADJUSTED RENEWABLE ENERGY | 111 |
| A-2.1 Accounting Table for Source Energy Offset by Adjusted Renewable Energy | 112 |
| A-3 OFF-SITE RENEWABLE ENERGY REQUIREMENTS | 113 |
| A-4 RENEWABLE ENERGY CERTIFICATE TRACKING | 115 |
| A-5 RENEWABLE ENERGY ALLOCATION TO MULTIPLE BUILDINGS | 115 |
| APPENDIX B – MOISTURE CONTROL GUIDELINES FOR OPAQUE ASSEMBLIES | 116 |
| B-1 GENERAL MOISTURE CONTROL GUIDELINES | 116 |
| B-1.1 Things to Avoid | 116 |
| B-2 MOISTURE CONTROL GUIDELINES FOR WALLS | 117 |
| B-2.2 Below-Grade Wall Assemblies | 120 |
| B-2.3 Masonry Walls and Freeze-Thaw | 121 |
| B-3 MOISTURE CONTROL GUIDELINES FOR ROOFS | 121 |
| B-4 Moisture Control Guidelines for Floors | 125 |
| B-4.1 Floors with Air Permeable Insulation | 125 |
| B-4.2 Below-Grade Floor Assemblies | 126 |
| APPENDIX C – METHOD FOR EVALUATING WHEN A COOLING SYSTEM IS RECOMMENDED | 127 |
| APPENDIX D - ASHRAE FUNDAMENTALS 2017 NON-RESIDENTIAL EQUIPMENT TABLES | 129 |
| APPENDIX E – PHIUS CERTIFIED RATER/VERIFIER MANUAL: VERSION 1.2 | 132 |
| E-1.0 DEFINITION & ELIGIBILITY | 132 |
| E-1.1 Phius Certified Rater | 132 |
| E-1.2 Phius Certified Verifier | 132 |
| E-1.2.1 Multifamily Designation | 132 |
| E-1.3 Third Party Status | 132 |
| E-2.0 CERTIFICATION REQUIREMENTS AND MAINTENANCE | 132 |
| E-2.1 PHIUS CERTIFIED RATER INFORMATION | 132 |
| E-2.1.1 Phius Certified Rater Exam Eligibility | 133 |
| E-2.1.2 Phius Certified Rater Certification | 134 |
| E-2.1.3 Phius Certified Rater Renewal | 134 |
| E-2.1.4 Phius Certified Rater Expiration | 134 |
| E-2.1.5 Phius Certified Rater Re-Activation | 134 |
| E-2.2 PHIUS CERTIFIED VERIFIER INFORMATION | 134 |
| E-2.2.1 Phius Certified Verifier Exam Eligibility | 135 |
| E-2.2.2 Phius Certified Verifier Certification | 135 |
| E-2.2.3 Phius Certified Verifier Renewal | 136 |

| | |
|---|------------|
| E-2.2.4 Phius Certified Verifier Expiration | 136 |
| E-2.2.5 Phius Certified Verifier Re-Activation | 136 |
| E-2.3 Non-Certified Inspectors | 136 |
| E-3.0 PRE-CONSTRUCTION REQUIREMENTS | 137 |
| E-3.1 Contracting with a Project | 137 |
| E-3.2 Project Team Training | 138 |
| E-3.3 Design Review | 138 |
| E-4.0 TECHNICAL INSPECTION AND FIELD REQUIREMENTS | 138 |
| E-4.1 Mid-Construction Inspections | 138 |
| E-4.2 Final Inspection and Testing | 139 |
| E-4.2.1 Verification | 140 |
| E-4.2.2 Testing | 140 |
| E-4.2.2.1 Whole-building airtightness | 140 |
| E-4.2.2.2 Duct leakage testing (where applicable) | 140 |
| E-4.2.2.3 Ventilation system testing | 141 |
| E-4.2.2.4 Heating and cooling system airflow testing | 142 |
| E-4.2.2.5 Bedroom pressure balancing | 142 |
| E-4.2.2.6 Hot water distribution system testing | 142 |
| E-4.3 Documentation | 143 |
| E-5.0 POST-CONSTRUCTION REQUIREMENTS | 144 |
| E-6.0 RESOURCES | 145 |
| Appendix F –Procedure to Prepare the Building for Airtightness Testing | 146 |
| F-1 ANSI/RESNET/ICC 380-2016 | 146 |
| F-1.1 Large Building Infiltration Testing | 148 |
| F-2 NON-THREATENING AIR LEAKAGE | 148 |
| APPENDIX G - PHIUS MULTIFAMILY CERTIFICATION PERFORMANCE REQUIREMENTS v2.3 | 151 |
| G-1.0 BUILDING CERTIFICATION | 151 |
| G-1.1 Program Eligibility Criteria | 151 |
| G-1.11 Energy Star MFNC Eligibility Criteria | 151 |
| G-1.12 EPA Indoor airPLUS Eligibility Criteria | 152 |
| G-1.13 DOE ZERH Eligibility Criteria | 152 |
| G-1.14 Non-Eligible Buildings | 153 |
| G-1.2 Effective Date | 153 |
| G-1.3 Phius Certified Rater/Verifier | 154 |
| G-2.0 ON-SITE VERIFIED PERFORMANCE CRITERIA | 154 |
| G-2.1 Sampling | 154 |
| G-2.2 Whole-building air tightness Testing | 155 |
| 2.2.1 Individual zone, “unguarded” testing | 156 |

| | |
|--|------------|
| 2.2.2 Individual zone, “guarded” testing | 156 |
| 2.2.3 Zone linking method | 157 |
| G-2.3 Dwelling unit compartmentalization | 158 |
| G-2.4 Heating and cooling air distribution system tightness testing | 158 |
| G-2.5 Heating, cooling and ventilation air distribution system measurement and balancing | 159 |
| G-2.6 Hydronic heating, cooling, and hot water systems appropriately tested and balanced | 160 |
| G-2.7 Installed HVAC, pump, motor, and lighting verification and electrical measurement | 160 |
| G-2.8 Demonstration of compliance with all ENERGY STAR MFNC, EPA IAP and DOE ZERH Certification Criteria | 160 |
| G-2.81 The Phius Path | 161 |
| G-2.9 Verification of Renewable Energy System Installation, or Renewable Ready | 161 |
| G-3.0 ENERGY MODEL-BASED PERFORMANCE REQUIREMENTS | 161 |
| APPENDIX H – PHIUS 2021 TARGET-SETTING UPDATES | 162 |
| H-1 TINY HOUSE STUDY | 162 |
| H-2 REVISED CURVE-FITS FOR SPACE CONDITIONING TARGETS | 163 |
| H-3 PRESCRIPTIVE PATH AIRTIGHTNESS LIMIT | 165 |
| APPENDIX I – INFORMATIVE | 166 |
| I-1 TIPS FOR PASSIVE BUILDING DESIGN | 166 |
| I-1.1 Tips to Design a Low-Cost Passive Building | 166 |
| I-1.2 Tips on Assemblies | 166 |
| I-1.2.1 Air Barrier | 166 |
| I-1.2.2 Perfect Wall | 166 |
| I-1.2.3 Slab Construction | 166 |
| I-1.2.4 Assembly R-Values | 167 |
| I-1.3 Tips on Windows | 167 |
| I-1.3.1 Window Certification Program | 167 |
| I-1.3.2 Window Condensation | 167 |
| I-1.3.2 Window Comfort | 168 |
| I-1.4 Tips on Ventilation | 168 |
| I-1.4.1 Exhaust Ventilation Devices | 168 |
| 1-1.4.2 Ventilation Fresh Air Supply | 168 |
| I-1.4.3 Ventilation System Capacity | 168 |
| I-2 SOURCE ENERGY | 168 |
| I-2.1 Source Energy Factors for Grid Electricity | 169 |
| I-2.2 Net Zero Source Energy | 169 |
| I-3 RATERS AND VERIFIERS | 169 |
| I-3.1 Overview of Typical Site Visits for the Rater/Verifier: | 170 |
| I-4 FIREPLACES | 170 |
| APPENDIX J - CO-GENERATION | 170 |

| | |
|---|------------|
| APPENDIX K - ELECTRIC VEHICLE CHARGING INFRASTRUCTURE | 174 |
| K-1 REQUIREMENTS | 174 |
| K-2 DEFINITIONS | 174 |
| APPENDIX L - ELECTRIFICATION READINESS FOR COMBUSTION EQUIPMENT | 176 |
| APPENDIX N - NORMATIVE | 178 |
| N-1 DHW DISTRIBUTION PIPE MATERIALS AND SIZES | 178 |
| N-2 MEDIAN ENERGY STAR APPLIANCES (EXPANDED) | 181 |
| N-3 MINIMUM INTERIOR SURFACE TEMPERATURE FOR THERMALLY BRIDGED CONSTRUCTION DETAILS | 182 |
| N-4 WINDOW COMFORT | 183 |
| N-5 RECIRCULATION DEFROST | 185 |
| N-6 NON-RESIDENTIAL BUILDING PROCESS LOADS | 185 |
| N-7 PRESCRIPTIVE PATH | 186 |
| N-7.1 Compactness Criteria | 186 |
| N-7.2 Solar Protection Criteria | 186 |
| N-7.2.1 Fenestration Orientation (for detached houses only) | 186 |
| N-7.2.1.1 For Cooling | 186 |
| N-7.2.1.2 For Heating | 188 |
| N-7.3 Thermal Enclosure | 188 |
| N-7.4 Mechanical Ventilation | 189 |
| N-7.4.1 Recovery Effectiveness | 189 |
| N-7.4.2 Fan Efficiency | 189 |
| N-7.5 Mechanical Systems | 189 |
| N-7.6 Lighting, Appliances & Water Heating | 190 |
| N-7.6.1 Lighting | 190 |
| N-7.6.2 Appliances | 190 |
| N-7.6.3 Water Heating | 190 |
| N-7.6.4 Performance Tradeoff Calculation | 191 |
| N-8 BLINDS | 193 |
| N-9 MULTI-UNIT LIGHTING & MEL CALCULATIONS | 193 |
| N-10 NON-RESIDENTIAL UTILIZATION PATTERNS | 199 |
| N-11 Domestic Hot Water Design Requirements | 201 |
| N-11.1 DOE ZERH Requirements | 201 |
| N-11.2 Definitions | 201 |

1. About Phius 2021

1.1 Introduction

Thank you for your interest in the Phius Passive Building Standard.

The Phius standard is a “high-performance building standard” – it challenges the building industry to construct buildings that can maintain a comfortable indoor environment with very low operating energy. Historically, the operating energy of a building over its lifetime far exceeded the embodied energy required to construct and maintain the building, thus the Phius standard focuses on reducing operating energy and does not specifically address the environmental impacts of the building materials and construction process. Low energy buildings, however, shift the balance between operational and embodied energy impacts and make consideration of embodied energy more critical than is the case with inefficient buildings. An historic illustration of embodied versus operating energy is shown in Figure 1.19 (a); how the balance shifts with increased efficiency is suggested in [Figure 1.19 \(b\)](#). Passive building designers should carefully consider the environmental impacts of materials selections, project compatibility with green building certification programs, and synergies with broader sustainability concepts.

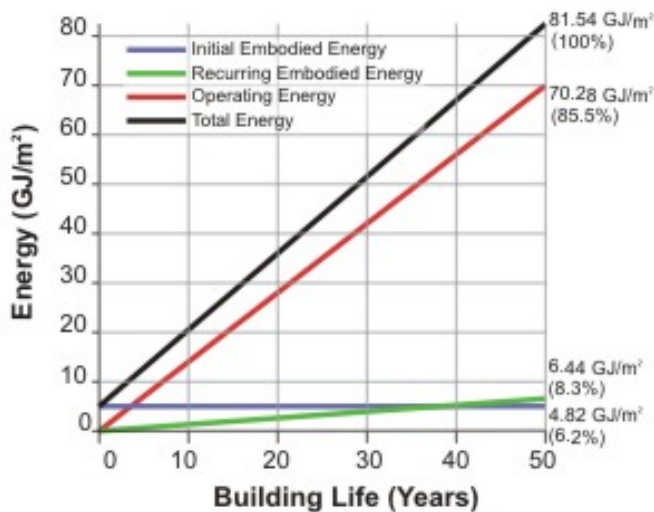

Components of Energy Use During 50-Year Life Cycle of Typical Office Building with Underground Parking, Averaged Over Wood, Steel and Concrete Structures in Vancouver and Toronto [Cole and Kernan, 1996].

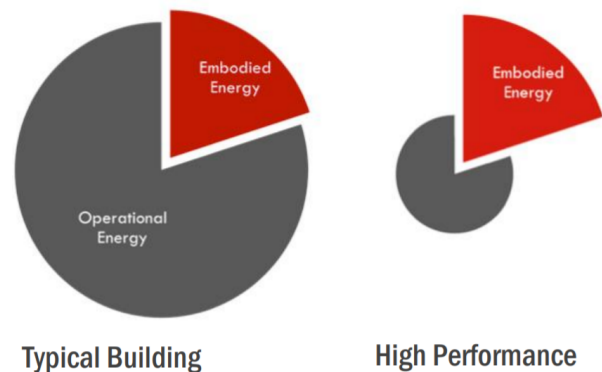

Figure 1.19(b). Example comparing embodied energy in typical vs high performance buildings. Source: [West Coast Climate Forum](#)

Figure 1.19(a). Example comparing operating energy and embodied energy of a building. []

The Phius standard is a pass-fail standard for building energy performance, with additional requirements for quality assurance inspections, and for low-moisture-risk design.

In 2014, under a grant from the [U.S. Department of Energy](#) (DOE), and in partnership with [Building Science Corporation](#), Phius developed PHIUS+ 2015—the first climate-specific passive building standard. The 2015 standard accounted not only for substantial differences between climate zones, but also for market and other variables, and retained rigorous conservation goals while making passive building more rational and cost effective. It recognized that there are diminishing returns on investment in energy-conserving measures, and an optimum level in a life-cycle cost sense, and that climate plays a large role in determining where that point is. For PHIUS+ 2015, researchers studied optimization in 110 cities, and developed interpolation formulas to set heating and cooling (space-conditioning) energy targets for 1000+ cities across the US and Canada. The same criteria applied to buildings of all sizes. PHIUS+ 2015 helped dramatically accelerate adoption. Download the full report at www.nrel.gov/docs/fy15osti/64278.pdf. [1]

Technologies, market conditions, carbon reduction goals and even climates could change over time. Consequently, Phius committed to revising the standard to reflect such changes. Phius 2021 is the second updated revision, and it has replaced PHIUS+ 2018. This update marks the next step towards making net zero universal. The updated standard has charged forward in two key areas: 1) New provisions that incentivize building electrification and 2) a prescriptive path for single family homes intending to help facilitate greater adoption.

Under Phius 2021, the same level of granularity is used for the climate-dependence of the heating/cooling criteria.

The particular focus of the Phius standard is on **reducing heating and cooling energy through passive measures**. In addition to an overall limit on energy use for all purposes, it features limits on heating and cooling energy, in both the annual-total and peak-power sense. The targets for these heating and cooling “loads” are climate-specific and have been set based on consideration of the best that can be achieved “cost-competitively”.

There is also one add-on badge available for buildings that reach even higher levels of performance beyond the Phius Standard – Supply Air Heating and Cooling Sufficient.

The energy performance is assessed based on calculation, a.k.a. mathematical modeling, using standardized climate conditions and occupant behavior. As such, it is a certification of a building design.

¹ Wright, Graham S., and Katrin Klingenberg. *Climate-Specific Passive Building Standards*. Golden, CO: National Renewable Energy Laboratory, 2015. Web. 13 May 2016. www.nrel.gov/docs/fy15osti/64278.pdf

Additionally, Phius certification emphasizes quality assurance. It requires additional reasonable assurances that projects are going to perform as designed, have healthy indoor environments, and be durable. To that end, Phius certification requires both Design review as well as third-party on-site quality assurance checks. Design review is performed by Phius staff, and final certification involves the participation of Phius-certified independent Raters or Verifiers who carry out on-site quality inspections (see [Section 3.6](#)).

Certification proceeds through two stages:

- **Design Certification** verifies that the *energy model* matches the plans and specifications.
- **Final Certification** verifies that the *finished building* matches the plans and specifications.

1.2 Why Certify?

The Phius certification process is the best way to build any project, from single-family homes to apartment buildings and commercial applications. Certification brings seasoned Phius reviewers onto your team who provide guidance and support for all project submitters. The Phius Certification process:

1. **Includes third-party verification**—This ensures the building is designed and constructed to meet the high-performance standards for energy use and that critical systems are commissioned into proper operation. Third-party verification is also typically required by the incentive programs of utilities and governments.
2. **Introduces risk management**—passive building requires special attention to moisture control and ventilation. Phius Certification staff and third-party QA/QC professionals can identify problem areas at the design stage before they become real-world problems.
3. **Builds and shares knowledge** —As more scenarios, project types and solutions pass through the certification process, Phius pays it forward to future project teams through direct feedback, building the public [Certified Project Database](#) and ongoing updates to this Guidebook.

1.3 About this Guide

The main goal is to help your project team design and execute high-performance, high-quality buildings and avoid as many pitfalls as possible.²

This Guidebook contains the following kinds of information, roughly in the order for which they are relevant in the building delivery process.

- General hints and tips for success.
- Design-phase requirements, both performance and prescriptive.
- Construction-phase requirements.
- The certification process, pricing, and roles of the parties involved.
- Energy modeling protocol.

1.4 The Project Team

Delivering a high-performance building requires exceptional cooperation between the design professionals and the building professionals. “Design-build” or “integrated-project-delivery” organization is more common in passive building and often mentioned as a success factor.

It is very preferable and highly recommended that a CPHC® (Phius Certified Consultant), Phius Certified Builder, and Phius Certified Rater/Verifier are all involved. However, the only professional that is required to have Phius training and certification is the Phius Certified Rater/Verifier.

1.4.1 Team Member Roles & Responsibilities

- **Phius Certified Consultant: CPHC®** – Recommended for all project types. Works with the project team throughout the design process to ensure the project will meet all certification requirements. This includes completing the WUFI® Passive energy modeling for performance path certification.
- **Phius Certified Builder: CPHB** – Recommended for all project types. The entity entrusted with comprehensively understanding the construction documents (plans and specifications) and executing them on site. The builder is charged with sourcing the intended materials per these documents and must then either install or manage the installation of all critical elements of the building envelope, mechanical, electrical, and plumbing systems. In addition to documenting the construction process, this role is also responsible for tracking any adaptations or alterations from the project documents and communicating them to the design personnel and CPHC. Coordination from the Builder with the Rater or Verifier is essential to ensure proper inspections and testing is completed.

²Simplicity is a popular idea in the abstract, but in practice a simple rule often meets objections that it is lacking some desired nuance in certain cases; as a result, certification protocol tends to become more elaborate over time.

- **Phius Certified Rater** – Required for single family detached and may be used for single family attached and townhouses. Responsible for site visits, testing, and verification during construction. They are an integral part of the project team and should be hired early in the process. A letter of intent must be secured from a Rater before Design Certification is issued.
- **Phius Certified Verifier** – Required for non-residential and multifamily projects and may be used for single family attached and townhouses. Responsible for site visits, testing, and verification during construction. They are an integral part of the project team and should be hired early in the process. A letter of intent must be secured from a Verifier before Design Certification is issued.

1.5 Types of Projects

As in RESNET, “residential” includes single-family detached, single-family attached, and multifamily buildings, excepting hotels and motels.

1.5.1 Single Family Residential Projects

Herein, “single-family” refers to single-family detached. What may elsewhere be called “single-family attached” housing is here considered to be “multifamily.” Single-family projects should follow the [Phius Single Family Quality Assurance Workbook](#). Any building designated as residential should be modeled with normal occupancy regardless of planned occupancy schedule. (i.e. vacation home, second home etc...). Phius has taken the stance of certifying the building and not the occupants. Over the lifespan of the building, the occupancy pattern may change.

1.5.2 Multifamily Residential Projects

Multifamily projects are defined as anything residential other than “single-family”. They should follow the [Phius Multifamily Quality Assurance Protocol](#) for quality assurance, prescriptive design requirements, and commissioning. All performance-based certification criteria remain the same as for single-family.

Modeling protocol for multifamily projects differs slightly from single-family because of the addition of common space lighting loads, elevators, shared spaces, etc., as noted in [Section 6.6](#).

Common Spaces: The term ‘common space’ refers to any spaces that serve a function in support of the residential part of the building that is not part of a dwelling or sleeping unit. This includes spaces used by residents, such as corridors, stairs, lobbies, laundry rooms, exercise rooms, residential recreation rooms, and dining halls, as well as offices and other spaces used by building management, administration, or maintenance in support of the residents.

1.5.3 Campus/Community Certification

For campus/community certification, where there are multiple residential buildings being certified that share a common site, building or space, a source energy limit applies for the campus/community as a whole. For example: laundry rooms and kitchens may be in a common shared space.

Space Conditioning: Each individual enclosure must be modeled separately, allocating the correct internal loads to each enclosure for accuracy of the internal heat calculation (ex: if all of the laundry is done in one building, the gains from this laundry should only be counted in that enclosure). The space conditioning targets (heating demand, heating load, cooling demand, cooling load) must be met for each enclosure in the separate energy models, and the airtightness requirements also apply for each enclosure individually.

Net Source Energy Allowance: If the campus/community is strongly/mainly residential in character the source energy allowance is proportional to the design occupancy. For non-residential day schools, commuter campuses and the like, the source energy allowance is per square foot of interior conditioned floor area (iCFA). See [Section 3.1.4](#) for specific target values.

1.5.4 Commercial/Non-Residential Projects

The criteria for non-residential projects are the same as for residential projects, apart from the Source Energy requirement. The Source Energy limit for commercial buildings is proportional to floor area, rather than occupancy. There may be additional differences that require additional documentation for Phius Certification.

Compared to residential projects, the energy models for non-residential projects need more detailed information on lighting systems, usage patterns, plug loads, and custom internal heat gains. For commercial buildings with process loads, Phius will determine the Source Energy allowance on a case-by-case basis. See [Appendix N-6](#) for process load definition.

For unique non-residential/commercial buildings with significant process loads, very high internal loads, or highly variable occupancy, custom optimization may need to be completed to determine the appropriate targets for Heating Demand, Cooling Demand, Heating Load & Cooling Load. Custom targets can be completed by Phius on a case-by-case basis using BEopt for an additional fee.

Non-Residential QA/QC Commissioning is required.

Download the [Phius Non-Residential Quality Assurance Workbook](#). Non-residential certification protocols will continue to be updated as more information becomes available on these types of projects.

1.5.4.1 Dorms & Hotels/Motels

The IBC/IECC codes draw the line between residential and commercial based on the number of stories and whether the occupancy is primarily “transient”, which means < 30 days. Transient occupancy is considered commercial.

Dorms:

Transient occupancy (< 30 days) = Commercial

Long term occupancy (> 30 days) = Residential

On-site prescriptive requirements: Phius Multifamily Protocol

Hotel/Motel: Commercial

On-site prescriptive requirements: Phius Commercial Protocol

1.5.5 Mixed-Use Projects

Submitting a Mixed-Use Project for Phius Certification

Overview

New-construction mixed-use projects come in two basic variants – in the first case, the usage types are known at design time. In the second case, part of the building is designed and finished for known usage types, and part of it is designed for some form of “shell lease”, wherein a tenant leases the unfinished shell of a building and agrees to complete construction by installing ceilings, plumbing, HVAC systems, electrical wiring, or even insulation. The degree of finish offered varies and is sometimes denoted by terms such as “cold dark box,” “warm white box,” which are not completely standardized. This document addresses certification and energy modeling protocol for both these cases, wherein the building is new construction and consists mostly of spaces “F” designed to be finished for known uses, and a smaller part “UF” intended for some form of non-residential shell lease.

Phius Mixed-Use Approach

It is encouraged to certify the whole building, but this is not required. Certification may be sought for part of the building only, even if all usage types are known at design time, as long as most of the building by floor area (50% or more) is within the scope of the planned certification.

Residential and non-residential parts of the building may be certified separately or together as a whole building. Due to software limitations, separate energy models are required if part of the building is residential and other parts non-residential, even if it is being certified

as a whole building. Multifamily common spaces that primarily serve the residents can be included in a residential energy model.

Parts “F” and part “UF” of the project must be separately metered and have separate mechanical systems. The predicted energy use can then be compared to actual usage.

Also, separate systems allow for flexibility in accommodating the differing schedules and capacities for the different usage types within the project. However, if all the usage types are known, the mechanical engineer may find it possible / advantageous to design a system with a shared thermal storage for low-temperature space conditioning.

It should be kept in mind that for any spaces that change tenants, (post-construction), modeled energy use may vary from predicted energy use.

If, between design certification and final certification, prospective tenants can be found for the parts UF who are able and willing to meet the constraints of whole-building certification in their build-out plans, the tenant fit-out may be certified under its planned function rather than as unfinished space.

The source energy allowance for residential spaces is calculated on a per person basis, and for nonresidential spaces on a per square foot basis ([3.1.4](#)).

Office and retail spaces do not qualify for an additional source energy allowance for process loads, but restaurants and groceries do. Contact Phius about process load allowances for other usage types.

General recommended practices include:

- Thermally isolating residential spaces from a nonresidential portion to some extent (for soundproofing and other considerations).
- Air sealing to separate the two parts to prevent odor transference.

Phius Protocol for modeling Unfinished spaces (UF):

- Building Type: Non-residential
- Occupancy Type: Undefined/unfinished
- Internal gains: 1 BTU/hr.ft²
- Continuous ventilation rate of 0.3 ACH (air changes per hour)
- Ventilation heat recovery efficiency matching the average for the rest of the building

The foregoing points pertain to calculating the heating and cooling loads and demands – it is necessary to assume a scenario to apply the certification criteria. For the source energy criterion that is not necessary – there is no additional source energy allowance for unfinished spaces and therefore no assumption about their energy use.

In general, there are 4 unique paths, listed below.

A) Whole Building Certification- One combined certification for Residential and Non-Residential

Separate energy models must be constructed for residential and nonresidential parts.

An overall source energy limit for the building applies, consisting of a per person portion for residential space, per-square-foot portion for nonresidential space, and additional custom process load allowance for some usage types. For details, please refer to the equation below, which uses Net Source Energy targets for Phius 2021.

$$\left(Res_{use} * Res_{Occ} * 3.412 \frac{kBTU}{kWh} \right) + \left(Non - res_{use,fin} * iCFA_{non-res,fin} \right) \leq \left(x \frac{kWh}{yr} * Res_{Occ} * 3.412 \frac{kBTU}{kWh} \right) + \left(24.5 \frac{kBTU}{ft^2.yr} * iCFA_{non-res,fin} \right) + PLA$$

Res_{use} = Primary Energy use in residential portion in kWh/person.yr

Res_{Occ} = Occupancy of residential portion

$Non - res_{use,fin}$ = Primary Energy use in kBtu/ft².yr of non-residential finished space

$iCFA_{non-res,fin}$ = Non-residential iCFA of finished space only

PLA = Process Load Allowance (case by case basis)

Space conditioning energy targets apply to the building as a whole and the floor area includes both parts. For details please refer to the equation below.

$$\left(X_{res} * iCFA_{res} \right) + \left(X_{non-res} * iCFA_{non-res} \right) \leq \left(X_{res,limit} * iCFA_{res} \right) + \left(X_{non-res,limit} * iCFA_{non-res} \right)$$

X_{res} = Specific Heating demand or Cooling Demand (kBtu/ft².yr), Heating Load or Cooling Load (BTU/ft².hr) modeled for the residential portion

$X_{non-res}$ = Specific Heating demand or Cooling Demand (kBtu/ft².yr), Heating Load or Cooling Load (BTU/ft².hr) modeled for the non-residential portion

$X_{res,limit}$ = Certification limit for the residential portion in kBtu/ft².yr or BTU/ft².hr

$X_{non-res,limit}$ = Certification limit for the residential portion in kBtu/ft².yr or BTU/ft².hr

$iCFA_{res}$ = Residential iCFA

$iCFA_{non-res}$ = Non-residential iCFA

Note: When calculating space conditioning targets for individual portions of a whole building, shared/adiabatic envelope area should not be included in the Envelope/iCFA ratio for any portion.

B) Whole Building Certification – Separate Residential and Non-Residential Certifications

Residential and nonresidential parts of the building are both modeled separately and certified separately, that is, they meet the certification criteria individually.

This separated approach is recommended for projects where the nonresidential spaces include a part UF. This way, the energy design for a main residential portion of the project can be settled earlier.

C) Partial Building Certification – One combined certification for Residential and Non-Residential

Same as A) above, except that only part of the building ($\geq 50\%$ by floor area) is certified.

D) Partial Building Certification - Separate Residential and Non-Residential Certifications

Same as B) above, except that only part of the building ($\geq 50\%$ by floor area) is certified.

| Mixed-Use Projects | | Whole Building Certification | | Partial Building Certification | |
|----------------------------|--|------------------------------|---|--------------------------------|---|
| | | A | B | C | D |
| Modeling / Certification | Separate energy models for residential & non-residential. | X | X | X | X |
| | 100% of building floor area modeled / certified. | X | X | | |
| | ≥ 50% of building floor area must be modeled / certified. | | | X | X |
| | Unknown non-residential spaces may not be certified alone. | | X | | X |
| | Follows UF Protocol outlined in Section 1.5.5 . | X | X | X | X |
| Source Energy Allowance | Determined for building by applying a mix of residential and non-residential allowances to certified spaces. | X | | X | |
| | Determined by space type (residential / non-residential). | | X | | X |
| Space Conditioning Targets | Apply to the whole / certified portion of the building. | X | | X | |
| | Apply to partial building and must be met in each energy model. | | X | | X |

- [A: One combined certification for Residential and Non-Residential](#)
- [B: Separate Residential and Non-Residential Certifications](#)
- [C: One combined certification for Residential and Non-Residential](#)
- [D: Separate Residential and Non-Residential Certifications](#)

1.5.6 Retrofit Projects

REVIVE is the designator used by Phius to differentiate retrofit projects from new construction. Phius CORE REVIVE 2021 and Phius ZERO REVIVE 2021 are the standards available for certification.

The criteria for retrofit projects are the same as for new construction. The following requirements are highlighted below for emphasis:

- Airtightness requirements are the same as for new construction (see [3.1.3](#)).
- Moisture risk requirement to maintain less than 80% RH on interior surfaces.
 - Any critical areas that need surface temperature calculation will be noted in design certification. The calculation will be performed in accordance with ISO 13788. Phius has a pre-approved ISO 13788 calculator available on the [Phius Resource Library](#).

The following exceptions apply:

- A case-by-case energy allowance may be made for hard/impossible-to-fix structural thermal bridges that cannot be mitigated, but have low risk from a moisture point of view (see requirement above on moisture risk).
 - The allowance noted above may also apply to existing assemblies that cannot be altered. To determine the allowance in WUFI Passive, the prescriptive path R-value for the associated location should be modeled. The difference in modeled performance results is equivalent to the allowance that may be applied. Phius has developed a Phius REVIVE 2021 Allowance Calculator that is available on the [Phius Resource Library](#).
 - Documentation should be provided from the project team describing the condition and the circumstances that prevent it from being altered.
 - **Example:** The allowance above may apply to uninsulated basement conditions where the slab cannot be removed, the foundation/structure cannot be changed and the floor-to-ceiling height is such that insulation above the slab cannot be installed.
- For measures and requirements outlined by the Co-requisite Programs ([See 3.6.1.1](#)) that cannot be met, it is the responsibility of the project team to apply for waivers or find an alternate, but equivalent method to meet the requirement/measure. This process should include the Rater/Verifier, their Quality Assurance Provider and the associated Program. Any exceptions allowed should be tracked and communicated back to Phius through the project feedback forms (either design or final certification feedback). Phius

has no ability to grant exemptions to the Federal Program requirements. The following government documents are linked below to provide teams with a starting point.

- [Current Energy Star Single-Family & Multifamily Policy Records](#)
- [Energy Star: Guidance for Homes and Buildings Undergoing Gut Rehabilitation](#)
- [Indoor airPLUS Current Policy Record](#)
- [Indoor airPLUS Exemption Request Process](#)
- [DOE Zero Energy Ready Homes \(ZERH\) 100% Certification Policy for Dwelling Units in Multifamily Buildings](#)

1.5.7 Buildings with Seasonal Use

Certification of seasonal-use buildings is discouraged, for two reasons.

1. First, if a building can be used year-round, it may tend to gravitate to year-round use over time - the intentions of the current or initial users notwithstanding.
2. Second, it is not fully supported by the current energy modeling software and requires significant workarounds.

Certification staff may allow it if there are other factors indicating that the seasonal use pattern will persist during the life of the building, e.g., "remote location on a seasonal road" and if the season of use encompasses at least half the year.

1.6 Program Version Eligibility

The date that the Phius Certification Contract is executed determines the program versions required for that project. Projects may voluntarily choose to comply with a newer version than required by contract date.

Please see the [Program Version Dates page](#) for the matrix of program version effective dates.

2. General Notes/Guidance

2.1 General Challenges Associated with Energy Efficient Buildings

Please be aware of these general issues with “super-insulated,” “low-load” buildings:

- Better insulation leads to colder exterior surfaces and less heat available to evaporate water in the assemblies. [³] See also [Appendix B](#).
- The “sensible heat ratio problem”, that is, HVAC dehumidification capacity at part load conditions. Sensible cooling demands and loads are reduced, while dehumidification demands and loads still exist. [⁴] [⁵]

2.2 “Yellow Flag” Items

Please [Contact Phius](#) early for more information if the project entails any of these items:

- Retrofit projects with foundation thermal bridges.
- Non-residential projects with “process loads” or unusual heating/cooling set point temperatures.
- Site altitude is very different from the nearest climate dataset location. See [Section 6.1.2](#) for more details.
- Thermal bridge calculations: [Contact Us](#) for assistance, or refer to Phius’ [Intro to THERM Workshop](#).
- No Phius Rater/Verifier within 100 miles of the project location. (See [Appendix E](#))

Please study the referenced information if the project entails any of these items:

- Spray foam, flash-and-fill assemblies: see [Appendix B](#).
- Double-stud walls: see [Appendix B](#).
- Floors with air-permeable insulation: see [Appendix B](#).
- Thermal mass, or anything more than “light construction”: see [Section 6.4.5](#).
- Heat pumps of any kind: [Review the Heat Pump related calculators here](#).

³ Lstiburek, Joseph. “BSI-028: Energy Flow Across Enclosures.” Building Science Corporation, 1 Dec. 2009. Web. 13 May 2016.

<http://buildingscience.com/documents/insights/bsi-028-energy-flow-across-enclosures>

⁴ Cummings, James. “Sensible and Latent Cooling Load Control Using Centrally-Ducted, Variable-Capacity Space Conditioning Systems in Low Sensible Load Environments.” Office of Energy Efficiency and Renewable Energy. energy.gov, 26 July 2012. Web. 16 May 2016.

<http://energy.gov/eere/buildings/downloads/sensible-and-latent-cooling-load-control-using-centrally-ducted-variable>

⁵ “Info-620: Supplemental Humidity Control.” Building Science Corporation, 19 May 2009. Web. 16 May 2016.

<http://buildingscience.com/documents/information-sheets/information-sheet-supplemental-humidity-control>

3. Building Certification Requirements

Phius offers two certification paths, performance and prescriptive. Any project may certify under the performance path, whereas the prescriptive path has a limited scope. Requirements outlined in Section 3 apply for each path and differences between paths are noted where applicable.

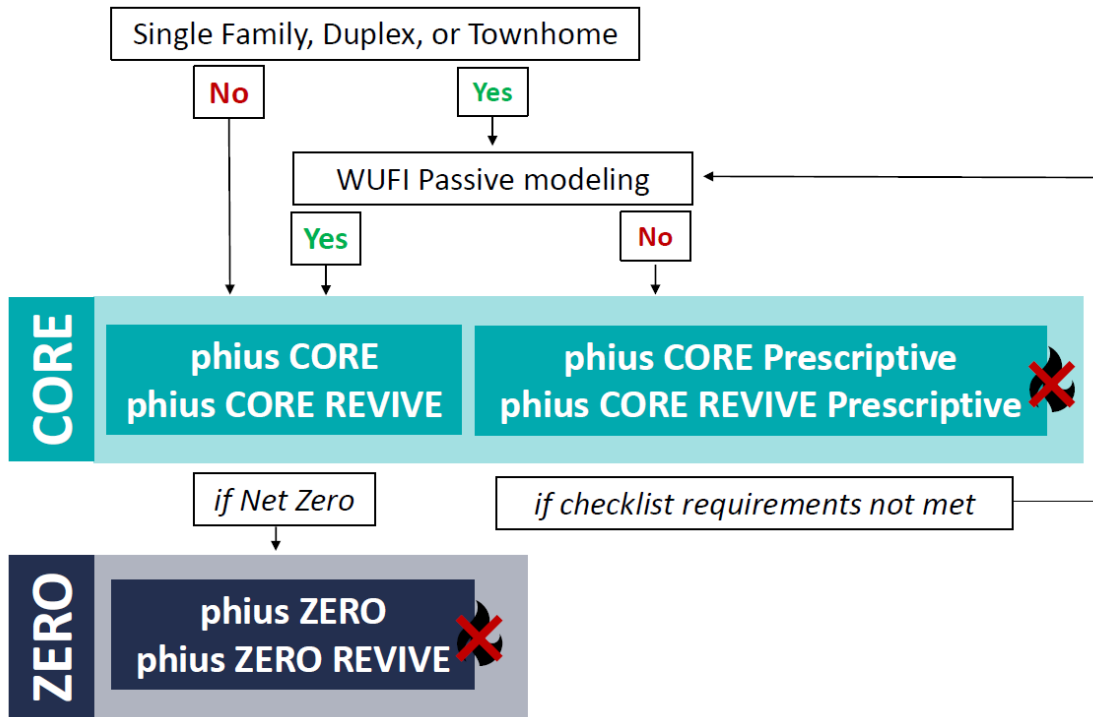

3.1 Overview of Requirements

3.1.1 Scope Requirements & Limitations

| Path | Performance | | Prescriptive |
|------------------------|---------------------------|---|--|
| New Const. | CORE | ZERO | CORE Prescriptive |
| Retrofit | CORE REVIVE | ZERO REVIVE | CORE REVIVE Prescriptive |
| Scope | All Building Types | | Single-family Detached Residences Duplexes Townhomes |
| Combustion Limitations | Electrification Readiness | No fossil-fueled combustion on-site. ⁶ | |
| Design Limitations | N/A | | <ul style="list-style-type: none"> • No indoor pools or jetted tubs. • Limit on the ratio of floor area to bedrooms. • Limits on fenestration area and orientation. |

⁶ Exception: Fossil-fueled combustion is allowed for emergency back-up generation of electricity, ie. back-up propane generator etc...

3.1.2 Passive Conservation Requirements

Each path guides the designer to use passive conservation strategies to limit heating and cooling demands on an annual and peak basis.

| Performance | Prescriptive |
|--|--|
| The performance path uses specific heating and cooling energy limits ⁷ for the project to guide investment in passive conservation strategies. These limits are applicable only when modeled using Phius' protocol and approved software . | The prescriptive path outlines requirements for individual passive conservation measures that must be implemented in the design. |
| <p>Space Conditioning Performance Criteria for Certification:</p> <p>Annual Heating Demand $\leq A$ (kBTU/ft².yr) Annual Cooling Demand⁸ $\leq B$ (kBTU/ft².yr) Peak Heating Load⁹ $\leq C$ (BTU/ft².hr) Peak Cooling Load² $\leq D$ (BTU/ft².hr)</p> <p>Limits are determined by the envelope area, floor area, occupant density, unit density (residential only), and location of the project.</p> | <p>Relevant sections of the Prescriptive Checklist:</p> <p>3. Compactness¹⁰ 4. Solar Protection³ 5. Thermal Enclosure³ Fenestration U-value limits Opaque R-value requirements 7. Mechanical Ventilation Sensible & Total Recovery Efficiency limits</p> |
| Refer to the Phius 2021 Criteria Calculator to determine criteria for the project. The values calculated are specific to | Refer to the Phius CORE Prescriptive Checklist to determine criteria for the project. |

⁷ The space conditioning criteria are all per square foot of interior Conditioned Floor Area (iCFA). See [Appendix H](#) for details on the development of Phius 2021.

⁸ Annual Cooling Demand is total cooling, latent plus sensible. Peak Cooling Load target is sensible only.

- Cooling criteria apply regardless of whether a cooling system is planned or not.
 - See [Appendix C](#) for a method to evaluate when a cooling system is recommended. It is recommended in most climates especially for residential projects.
- Certification staff may require that occupant-installed cooling, e.g. window A/C, is included in the energy model, even if it is not designed into the building as-delivered, so that the impact on source energy use is accounted for.

⁹ The peak loads calculated in WUFI Passive should not be used for mechanical system sizing. All Phius projects require a Manual J calculation. Helpful reference may be: [Strategy Guideline: Accurate Heating and Cooling Load Calculations by Arlan Burdick IBACOS, Inc.](#)

¹⁰ Review [Appendix N-7](#)

3.1.3 Airtightness Requirements

The pass/fail certification requirement is per square foot of gross enclosure surface area¹¹ and has varying limits based on test pressure. The limits are as follows:

| Performance | | | Prescriptive | | |
|--|--|--|---|--|--|
| Building Type | 50 Pa | 75 Pa | Building Type | 50 Pa | 75 Pa |
| ≥5 Stories & Non-combustible* | $q \leq 0.080$ CFM ₅₀ /ft ² | $q \leq 0.110$ CFM ₇₅ /ft ² | Single-family detached, attached and townhomes | $q \leq 0.040$ CFM ₅₀ /ft ² | $q \leq 0.053$ CFM ₇₅ /ft ² |
| All other buildings | $q \leq 0.060$ CFM ₅₀ /ft ² | $q \leq 0.080$ CFM ₇₅ /ft ² | | | |

*Non-combustible in this sense is construction that is not subject to mold and rot. This would mean no wood-based framing members or sheet goods, and no wood-based or paper-based insulation.

A whole-building test for air tightness must be performed. For further details, see:

[Appendix E - Rater/Verifier Manual](#)

[Appendix F - Procedure to Prepare the Building for Airtightness Testing](#)

If testing at 75 Pa, report the flow coefficient and exponent from the blower door tests so that the test result can be converted to 50 Pa for the as-built energy model and final records.

For non-threatening air leakage: If the airtightness criterion is missed, and the extra leakage can be proven to be due to a non-assembly-threatening leakage element, certification staff may allow that element to be taped off for the purpose of passing the airtightness criterion. **The un-taped test result must be used for the energy model.** See [Appendix F-2 Non-Threatening Air Leakage](#).

3.1.4 Active Conservation Requirements

In addition to using passive conservation strategies to limit the needs for heating and cooling, the overall performance must be addressed in the design. This includes all other energy end-uses for the building. Each path guides the designer to investments in active conservation strategies to limit the building's overall energy use.

There are two certification "tiers" available, CORE and ZERO.

Phius CORE sets a target that is challenging but achievable with conservation measures only and

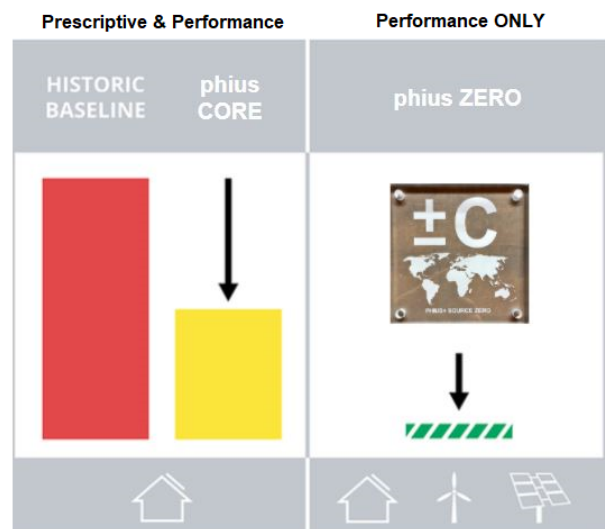

¹¹ Gross enclosure area is measured at the exterior of the thermal boundary, the same as for the energy model, and includes surfaces in contact with the ground.

has both a performance path for all buildings and a limited-scope prescriptive path for new construction single family / townhomes.

Phius ZERO is built upon CORE but sets the net source energy target at 0.

These also differ with respect to how renewable energy is regarded as offsetting source energy use, as outlined in [Appendix A – Renewable Energy](#).

| Performance | | Prescriptive |
|--|---|---|
| CORE | ZERO | CORE |
| The performance path uses a source energy target to limit overall energy use. | | The prescriptive path uses individual appliance and equipment efficiency measures to limit overall energy use. |
| Net Source Energy Demand ^{12,13} ≤ E | Net Source Energy Demand ^{6,7} ≤ 0 | Relevant sections of the Prescriptive Checklist: 8. Mechanical Systems ¹⁴ 9. Lighting, Appliances & Water Heating ⁸ |
| Refer to the Phius 2021 Criteria Calculator to determine specific limit for the project. | | Refer to the Phius CORE Prescriptive Checklist to determine criteria for the project. |

¹² The number of persons is taken to be the number of bedrooms+1, on a unit-by-unit basis (e.g., four 2-bedroom units have a design occupancy of 12, not 9). For studio apartments where there is no defined bedroom, the occupancy should be assumed to be the number of bedrooms (0)+1 = one occupant per studio.

¹³ For non-residential buildings, the Net Source Energy limit is proportional to the floor area instead of occupancy.

¹⁴ Review [Appendix N-7](#)

3.1.4.1 Source Energy Limits

| Performance | | | | | | |
|---|---|-------------------------|------------------------|--|-------------------------|------------------------|
| Tier | CORE | | | ZERO | | |
| Net Energy Accounting | Source Energy demand is calculated as the annual usage <i>net of</i> renewable energy that is <i>produced and used directly on-site</i> . Renewable energy production that is exported from the site or generated off-site is not credited. | | | Source Energy demand is calculated as the annual usage <i>net of</i> all on-site & off-site renewable energy procured. | | |
| Residential Buildings ¹⁵ | Net Source Energy Demand ^{6,16} ≤ E (kWh/yr/person) | | | Net Source Energy Demand ⁶ ≤ 0 (kWh/yr/person) | | |
| Non-Residential Buildings ¹⁷ | Net Source Energy Demand ⁷ | | | Net Source Energy Demand ⁷ | | |
| | kBTU/ft ² /yr | kWh/ft ² /yr | kWh/m ² /yr | kBTU/ft ² /yr | kWh/ft ² /yr | kWh/m ² /yr |
| | ≤ 24.5 | ≤ 7.2 | ≤ 77.3 | ≤ 0 | ≤ 0 | ≤ 0 |
| | Process load ¹⁸ allowances may increase the source energy limit. Phius will determine the source energy allowance on a case-by-case basis. | | | Process load allowances do not increase the source energy limit. | | |
| Mixed-Use Buildings ¹⁹ | The residential SE limit applies if the building has common spaces and conditioned spaces that are not dwelling units, but that primarily serve the residents. ¹¹ | | | | | |
| | For non-residential spaces designed to mainly serve non-resident clientele, an additional SE allowance may be calculated using the Non-Residential limits, based on the iCFA of those spaces. ²⁰ | | | No additional SE allowance provided for spaces serving non-resident clientele. | | |
| Unfinished Spaces | No source energy allowance for unfinished spaces and no source energy impact associated with the internal gains. See Section 1.5.5 . | | | | | |
| Off-grid Buildings | Process load allowance is provided for indoor water supply and/or wastewater treatment ²¹ . Residential = 800 kWh/person/yr for Non-Residential = 14 kWh/kgal | | | No process load allowance given. | | |

¹⁵ Include single-family detached housing, single-family attached housing, multifamily buildings, excepting hotels and motels.

¹⁶ The net source energy (SE) limit for all residential buildings varies by occupant and unit density.

¹⁷ See [Section 4.4.1.4](#) for the iCFA calculation rules.

¹⁸ Process Load: Services being provided to a customer or client in the building, this is considered a process load. Whether it is the customer or client using the energy (ex: arcade, training center), or if the energy is used on their behalf (ex: restaurant), both situations qualify as process loads.

¹⁹ Certification staff may require separate modeling of the residential and non-residential parts of a mixed-use building.

²⁰ The nonresident occupants of such spaces (staff and customers) are not included in the occupant count for determining the per-person portion of the source energy allowance. (Nor do they determine lighting and miscellaneous energy use of the common spaces, as explained in [Section 6.6.1.1](#)).

²¹ Allowance is cut in half if a project is off-grid for water supply only or wastewater treatment only.

3.1.4.2 Lighting, Appliance, & Equipment Efficiencies

See relevant requirements in Section 3.5.

3.2 Renewable Energy Requirements

| Performance | | Prescriptive |
|--|--|--|
| CORE | ZERO | CORE |
| Renewable energy is not required, but some on-site renewable energy is credited. | The adjusted renewable energy provided to the project must be equal to or greater than the modeled energy use of the building. | Renewable energy is not required, nor credited as offsets. |

Any combination of conservation measures and renewable energy can be used to meet the net source energy criterion for the Performance path. See [Section 6.10.9](#) on modeling protocol and [Appendix A – Renewable Energy](#) for details on acceptable system types, contract requirements, calculating adjusted renewable energy and renewable energy allocation to multiple buildings.

3.3 Moisture Design Criteria for Assemblies and Details

3.3.1 Opaque Assembly Moisture Design Requirements

It is important to avoid risks related to mold and moisture.

There are three compliance paths:

- Follow the prescriptive moisture control guidelines in [Appendix B](#).
- Meet performance criteria by WUFI Pro hygrothermal analysis, according to the protocol [found here](#) (fee may apply, see also [Section 5.4](#)). More in [Appendix I-3](#).
- Present a moisture-engineered design by a qualified licensed professional engineer that includes the following language
 - Acknowledgement that Phius flagged the assembly for potential hygrothermal or moisture concern
 - Note that Phius is not held responsible for any moisture issued
 - Outline that the potential hygrothermal or moisture risk of the assembly as designed is acceptably low

3.3.2 Fenestration Moisture Design Requirements

When calculated according to ISO 13788, the interior surface temperature of the fenestration must avoid condensation risk. This requires that the lowest temperature on the inside surface results in less than 100% relative humidity at the surface, when the interior air is chilled down to that temperature.

Use Phius' [Window Comfort & Condensation Risk Assessment Calculator](#) to:

1. Look up the required fRsi for a given project.
2. Test compliance with any of the methods outlined below.

The Fenestration Condensation Resistance requirement, fRsi, must be met by one of the following methods:

1. General Frame Type U-value
2. U-Frame (Uf) inferred from U-Window (Uw) and U-Center of Glass (Ucog)
3. AAMA 1503 Condensation Resistance Factor (CRF)
4. NFRC 500-2020 Condensation Resistance
5. CAN/CSA A440.2 Temperature Index
6. fRSI Method²²

Exception 1: Dog doors are not required to pass the condensation resistance test.

Exception 2: The whole door U-value may be used for the condensation risk assessment for exterior doors that are required to be ADA compliant, egress rated, fire rated, etc., instead of requiring that each of the individual elements pass (glazing and frame).

3.3.3 Thermally Bridged Construction Detail Requirements

When calculated according to ISO 13788, the interior surface temperature of thermally bridged construction details must avoid mold growth. This requires that the lowest temperature on the inside surface results in less than 80% relative humidity at the surface, when the interior air is chilled down to that temperature.

More details and calculation compliance tools can be found in [Appendix N-3](#).

3.4 Window Comfort Requirements

The maximum whole-window U-value that may be used in a building pursuing Phius certification is set based on the window height and ASHRAE 99% design temperature for that location.

The window comfort criterion applies to all projects, regardless of size. The U-value required scales by window height – the taller the window, the lower the required U-value, and can be calculated here: [Phius Window Comfort & Condensation Risk Assessment](#)

More details and exceptions can be found in [Appendix N-4](#).

3.5 Mandatory Design Requirements

Most of the following requirements come from prerequisite programs and are the responsibility of the builder but there are some items that concern the designer as well. Phius-specific requirements are listed individually, while prerequisite program requirements

²² Passivhaus Institut (PHI) Certified Component Data

are provided as references to sections with hyperlinks to specific documents. The order of items and numbering conventions of specific line items are meant to align with the structure of the [Phius Quality Assurance Workbooks](#) but may differ slightly depending on the type of project (single-family, multifamily or non-residential). Please [Contact Us](#) for any broken hyperlinks.

3.5.1 Building Envelope

3.5.1.1 Universal Requirements:

1.4: Perform thorough infrared scan of the entire building from interior and exterior and document representative photos. Follow RESNET Infrared inspection guidelines for minimum delta-T. Images should include walls, insulated ceilings, slabs, windows. Use picture in picture if camera has the capability.

3.7: Other Thermal Bridging/mitigation strategy identification: Note any other meaningful thermal bridges observed on the project, as well as thermal bridging mitigation strategy identification. Special effort should be made to clearly document such bridging and mitigation strategies, or where such details are missed.

- The Phius Rater or Verifier shall discuss the presence of known thermal bridges with CPHC prior to inspection, as well as specific mitigation strategies. Any significant bridging observed on a project not accounted for by the CPHC must be brought to the attention of Phius immediately.

3.5.1.2 Single-family, Duplex and Townhouse requirements:

- [ENERGY STAR Single-Family New Homes National Rater Field Checklist, Version 3 / 3.1 \(Rev. 11\)](#)
 - Section 1 requirements
 - For reference to section 1.3: [RESNET Normative Appendix A: Inspection Procedures for Insulation Grading and Assessment](#)
 - Section 2 requirements
 - Section 3 requirements
 - Section 4 requirements
- [DOE ZERH National Program Requirements, Version 1, Rev. 08](#)
 - Section 2

3.5.1.3 Multifamily, Mixed-Use & Non-residential Requirements:

- [ENERGY STAR MFNC National Program Requirements, Version 1.2 \(Rev. 03\)](#)
 - Envelope, Windows, & Doors
- [DOE ZERH National Program Requirements, Version 1, Rev. 08](#)
 - Section 2

3.5.2 Ventilation

3.5.2.1 Balanced Ventilation

- A whole-building mechanical ventilation system is required to be installed.
- The system shall have at least one supply or exhaust fan with associated ducts and controls. Local exhaust fans can be part of a whole-house ventilation system.
- **For Phius certification, regardless of type, the ventilation system must meet one of the following requirements for balance:**
 1. Total measured supply and exhaust airflows are within 10% of each other.
 - a. Only continuous ventilation counts towards the airflow balance.
 - i. Do not include intermittent exhaust ventilation.
 - b. Use the higher number as the basis of the percentage difference.
 2. The total net pressurization or depressurization from the un-balanced ventilation system does not exceed 5 Pa. The net pressurization/depressurization that the ventilation system imbalance causes on the building is determined using the multi-point air-tightness test results graph.
- **In the case of ventilation ductwork integrated with heating/cooling ducts, ERV should remain in balance under all fan speeds of the heating/cooling air handler.**
- Residential building minimum ventilation rates are determined by the largest of two factors
 - Supply air requirement (based on occupancy). A minimum of 15 cfm per person should be provided. (18 cfm per person is recommended). Refer to section [6.3.1.1](#) for occupancy calculations of buildings with dwellings. For non-residential buildings, the design or maximum occupancy should be used to size the system.
 - Exhaust air requirement (based on kitchens, baths, etc..) Review section [3.5.2.3](#) for minimum exhaust airflow requirements.

In the Energy Star framework, the ventilation system type is characterized as either “Supply”, “Exhaust”, or “Balanced”.

In the case of “Supply” or “Exhaust” systems:

A ventilation system design with supply fans only or exhaust fans only will generally require dedicated openings in the envelope (with dampers) for make-up air to meet the balance requirements, because of the air-tightness requirement on the building overall. Review the [Exhaust fans and make-up air blog](#) and [Intermittent Exhaust Calculator](#) to determine when make-up air is required. Such make-up air inlets or outlets must appear in the design documentation for Design Certification.

In the case of “Balanced” systems with heat or energy recovery devices:

If the exhaust or supply air flow exceeds the exhaust air flow by more than 10%, the energy penalty must be accounted for per Section 6, Energy Modeling Protocol.

3.5.2.2 Ventilator Defrost

A pre-heater defrost (or ground loop pre-heater) is required for ERVs where the ASHRAE 99.6% design temperature is below the manufacturer's claimed minimum operating temperature, rather than relying on recirculation defrost.

If the unit can maintain the required fresh air ventilation rates on average with the unit intermittently in recirculation mode, then this is acceptable. The unit needs to have enough boost to maintain the same time-average fresh air ventilation rate as it would at higher temperatures. See [Appendix N-5 Recirculation Defrost](#) for requirements.

3.5.2.3 Quality Assurance Workbook Requirements

- [National HVAC Design Supplement to Std. 310 for Dwellings & Units](#)
 - [ENERGY STAR Single-Family New Homes, All Versions \(Rev. 12\)](#) & [ENERGY STAR Multifamily New Construction, All Versions \(Rev. 03\)](#)
 - Section 2
 - Section 3
 - Section 5
- [EPA Indoor airPLUS Construction Specifications Version 1 \(Rev. 04\)](#)
 - HVAC Systems

1.3b: All ventilation air inlets located minimum 5' from ventilation exhaust outlet, recommended 10'

1.8: Air-sealed, class 1 vapor retarder shall be installed over all air-permeable insulation (such as fiberglass duct wrap) on ventilation ducts connected to outside

1.9: Dedicated Fresh Air supply to all bedrooms

Fresh air (OA) supply to bedrooms is **required** in all dwelling units:

- In the case of ventilation ductwork integrated with heating/cooling ducts, the heating/cooling air handler fan must be designed to run continuously by default.

1.12a: Note future update to align with EPA Indoor airPLUS v2 (permit date 01/01/2025 and later) – Direct, intermittent kitchen exhaust is required in only single family, duplex, and townhomes.

1.13: If kitchen exhaust connected to ERV/HRV, register must be a minimum of 6' ("stretched-string distance") from the cooktop, MERV 3 or washable mesh filter for trapping grease, and recirculation hood over range.

2.1: Total supply and exhaust are within 10% of each other

2.1: Alternative compliance path: net pressure across envelope no greater than +/- 5 Pa

3.5.3 Heating, Cooling & Domestic Hot Water

Heating/Cooling Equipment

1.7: If a combustion equipment for space heating, the building has provided a designated exterior location(s) in accordance with the following:

Exception: Where an electrical circuit in compliance with IRC Section E3702.11 exists for space cooling equipment.

1.7A: Natural drainage for condensate from cooling equipment operation or a condensate drain located within 3 feet

1.7B: A dedicated branch circuit in compliance with IRC Section E3702.11 based on heat pump space heating equipment sized in accordance with R403.7 and terminating within 3 feet of the location with no obstructions. Both ends of the branch circuit shall be labeled "For Future Heat Pump Space Heater."

Heating/Cooling Distribution – Ducted systems only

- [National HVAC Design Supplement to Std. 310 for Dwellings & Units](#)
 - [ENERGY STAR Single-Family New Homes, All Versions \(Rev. 12\)](#) & [ENERGY STAR Multifamily New Construction, All Versions \(Rev. 03\)](#)
 - Section 5
- [DOE ZERH National Program Requirements, Version 1, Rev. 08](#)
 - Section 3
- [EPA Indoor airPLUS Construction Specifications Version 1 \(Rev. 04\)](#)
 - HVAC Systems

Combustion Safety and Condensation Management

- [ENERGY STAR Single-Family New Homes National Rater Field Checklist, Version 3 / 3.1 / 3.2 \(Rev. 12\)](#)
 - Section 10
 - Alternatives in Footnote 68 do not apply for Phius projects.

4.5: Corrosion-resistant drain pan, properly sloped to drainage system is included with each HVAC component that produces condensate.

Domestic Hot Water Systems

- [DOE ZERH National Program Requirements, Version 1, Rev. 08](#)
 - Section 4
- Appendix [E-4.2.2.6](#)

- Appendix [N-11](#)

6.8: If combustion water heating and water heater capacity is less than or equal to 300,000 Btu/h (88 kW) the following are met:

6.8A: A dedicated 240-volt branch circuit with a minimum capacity of 30 amps shall terminate within 3 feet from the water heater and be accessible to the water heater with no obstructions. Both ends of the branch circuit shall be labeled with the words "For Future Heat Pump Water Heater" and be electrically isolated.

6.8B: A condensate drain is installed within 3 feet of the water heater. It is no more than 2 inches higher than the base of the installed water heater and allows natural draining without pump assistance.

6.8C: The water heater is installed in a space with minimum dimensions of 3 feet x 3 feet x 7 feet high.

6.8D: The water heater is installed in a space with a minimum volume of 700 cubic feet or the equivalent of one 16-inch x 24-inch grill to a heated space and one 8-inch duct of no more than 10 feet in length for cool exhaust air.

3.5.4 Lights, Appliances, & Renewables

Lighting

- [DOE ZERH National Program Requirements, Version 1, Rev. 08](#)
 - Section 5

Appliances

- [DOE ZERH National Program Requirements, Version 1, Rev. 08](#)
 - Section 5
- [EPA Indoor airPLUS Construction Specifications Version 1 \(Rev. 04\)](#)
 - HVAC Systems
- For combustion appliances, review requirements outlined in [Appendix L](#)

Renewable Energy Systems

Phius requires homes to be solar PV-ready regardless of average daily solar radiation (kWh/m²/day). Phius projects are **not** exempt even if daily average solar radiation for the site is less than 5 kWh/m²/day.

- [DOE ZERH PV-Ready Checklist](#)

3.5.5 Water Management and Indoor Air Quality

Requirements outlined in the prerequisite program documents noted below apply to all Phius projects.

- [ENERGY STAR Single-Family New Homes National Water Management System Builder Regs, Version 3 / 3.1 \(Rev. 11\)](#)
- [EPA Indoor airPLUS Construction Specifications Version 1 \(Rev. 04\)](#)
 - Moisture Control
 - Additional Exceptions outlined under checklist 1.4 do not apply for Phius projects: Language struck through below does not apply.
 - ~~In lieu of perimeter wall insulation and conditioned air, crawlspaces that utilize a capillary break on the floor and that are well-sealed to prevent outside air infiltration are permitted to utilize active dehumidification with sufficient latent capacity to maintain relative humidity (RH) at or below 60 percent. The dehumidifier shall be drained to the outside or to a sump pump. With this exception, ENERGY STAR Certified Homes Water Management System Builder Requirements Item 1.4.3 staking method for poly sheeting may not be used in crawlspaces with no slab.~~
 - Radon
 - Materials

In addition to the prerequisite requirements noted in the documents above, Phius has additional requirements noted below. While the numbering conventions for these requirements come from the single-family quality assurance workbook (v4.2.1), they apply to all Phius projects.

Water Managed Walls/Roofs

2.1: Flashing at bottom of exterior walls with weep holes included for masonry veneer and weep screed for stucco cladding systems or equivalent systems. (or equivalent system)

2.3: Window and door openings fully flashed. Apply pan flashing over the rough sill framing, inclusive of the corners of the sill framing; side flashing that extends over pan flashing; and top flashing that extends over side flashing or equivalent details for structural masonry walls.

2.4: Step and kick-out flashing at all roof-wall intersections, extending $\geq 4''$ on wall surface above roof deck and integrated shingle-style with drainage plane above; boot / collar flashing at all roof penetrations." Intersecting wall siding shall terminate 1 in. above the roof or higher, per manufacturer recommendations. Continuous flashing shall be installed in place of step flashing for metal and rubber membrane roofs.

3.5.6 Electric Vehicle (EV) Charging Infrastructure

Infrastructure for the current and future charging of electric vehicles (EVs) is required for all residential buildings where parking spaces are planned.

The number of EV Ready and EV Capable Spaces required depends on the building's parking requirement.

The summary is below, further details and definitions can be found in [Appendix K](#).

One- to two-family dwellings and townhouses: 1 EV-Ready space per dwelling unit.

Multifamily dwellings (three or more units): Per table below, round up to the nearest whole number.

| Total # of Parking Spaces | Minimum number of EV Ready Spaces | Minimum number of EV Capable Spaces |
|---------------------------|-----------------------------------|-------------------------------------|
| 1 | 1 | - |
| 2-10 | 2 | - |
| 11-15 | 2 | 3 |
| 16-20 | 2 | 4 |
| 21-25 | 2 | 5 |
| 26+ | 2 | 20% of total |

Table **EV**: Electric Vehicle Ready Space and EV Capable Space requirements

Campus: For a neighborhood or development with multiple buildings where no individual building parking is provided, a “campus” approach can be taken to apply to the EV requirements. In this case, treat the development as a single project and use the total number of parking spaces provided with Table **EV** to determine requirements.

Non-Residential Buildings: N/A for Phius 2021 projects. Future requirements TBD.

3.5.7 Combustion Equipment & Fireplaces

Combustion equipment requirements are outlined in QA Checklist requirements and re-configured below for emphasis and clarity.

3.5.3.1 Fossil-Fueled Combustion Equipment

Fossil-fueled combustion equipment is not permitted in ZERO, ZERO REVIVE, CORE Prescriptive or CORE REVIVE Prescriptive projects.

Combustion heating/water heating systems located within the buildings' pressure boundary must be sealed, direct-vent appliances.

3.5.3.2 Fireplaces

Natural draft fireplaces are not permitted. Installed fireplaces and woodstoves must have a combustion air inlet connected to an airtight firebox. See [Appendix I-4](#).

| Combustion Limitations | Performance | | Prescriptive |
|---|-----------------------|---------------------------|--|
| | CORE / CORE REVIVE | ZERO / ZERO REVIVE | CORE Prescriptive / CORE REVIVE Prescriptive |
| Fossil-Fuel based Equipment (sealed combustion) | Allowed ²³ | | Not Allowed |
| Fireplace (Natural Gas) | Allowed ²⁴ | | Not Allowed |
| Fireplace Insert / Woodstove (Biomass-burning) | | Allowed ²¹ | |
| Fireplace (Open/Unvented) | | Not Allowed | |
| Fireplace (Ethanol) | | Not Allowed ²⁵ | |

3.5.3.3 Electrification Readiness

Electrification Readiness is required for any combustion equipment used in Phius CORE 2021 and Phius CORE REVIVE 2021 projects. This includes all non-electric equipment: combustion-based equipment for water heating, space heating, clothes drying, cooking, and other equipment. Details can be found in [Appendix L](#).

3.6 Mandatory On-Site Requirements and Rater/Verifier Information

3.6.0 Personnel Required

Before **Design Certification** is awarded to a project, Phius requires a letter of intent from the Phius Certified Rater* or Phius Certified Verifier* on the project, stating they have been hired to complete the on-site verification and quality assurance process.

*Exception: Non-Certified Inspectors may be used based on constraints of the project location. See [Appendix E Section 2.3](#)

²³ Must comply with Electrification Readiness requirements.

²⁴ Must be vented to the outside, with an airtight stove or fireplace box.

²⁵ Per EPA Indoor airPLUS

The Phius Certified Rater or Phius Certified Verifier is responsible for ensuring compliance with all requirements outlined below. See also [Appendix I-3](#).

3.6.1 Residential

3.6.1.1 Co-Requisite Program²⁶ Requirements

The following are required for all single-family projects and all other eligible residential projects.

- EPA ENERGY STAR Certified Homes / Multifamily New Construction (MFNC)
- EPA indoor airPLUS (IAP)²⁷
- DOE Zero Energy Ready Home (ZERH)²⁸

Single family homes and duplexes should use the [Phius Single Family Quality Assurance Workbook](#). All individual program checklists are required to be completed and submitted along with the QA Workbook.

Townhouses may fall under the single family or multifamily program. Follow the requirements in Appendix G for eligibility requirements.

Multifamily²⁹ buildings should use the [Phius Multifamily Quality Assurance Workbook](#). For full program requirements and program eligibility criteria, please see [Appendix G: Phius Certification for Multifamily Performance Requirements \(v2.3\)](#). All individual program checklists are required to be completed and submitted along with the QA Workbook.

3.6.1.2 Residential Exceptions

Generally, the only cases where an eligible residential Phius project may **not** earn ENERGY STAR, EPA Indoor airPLUS or DOE ZERH certifications are:

1. **Existing Buildings:** Some retrofits, gut rehabilitations, partial renovations, or unforeseen circumstances that may arise. In such cases, a written submission should be sent to Phius for review during design certification.
2. **Project Location not Eligible for Certification:** Projects in Alaska, or other locations outside of the US. While earning the actual certification is not required, the project must still meet all certification criteria.

²⁶ Check the policy record for each program as to the current version and applicability to the project's location.

²⁷ Review the [proposed revisions to Indoor airPLUS Version 2](#).

²⁸ Review the [DOE ZERH v1 Rev8 and Version 2 summary of changes](#).

²⁹ See [Section 1.5.2](#) for definition of multifamily

3.6.2 Non-Residential

3.6.2.1 Co-Requisite Program Requirements³⁰

Non-Residential projects shall use the eligibility criteria and follow checklist requirements for:

- EPA ENERGY STAR Multifamily New Construction (MFNC) Program³¹
- EPA Indoor airPLUS (IAP)
- DOE Zero Energy Ready Homes (ZERH)

Mixed-Use Buildings: Dwelling and sleeping units must be certified to the co-requisite programs above.

Non-residential buildings (and non-residential spaces within mixed-use buildings): Exempt from certifying under those programs however, the certification checklist criteria for these programs shall still be achieved to help ensure that Nonresidential projects seeking Phius Certification are not only energy efficient, but also durable, comfortable, and healthy buildings.

General concepts below – details are outlined in the [Phius Nonresidential Quality Assurance Workbook](#).

The initial scope of requirements for commissioning of nonresidential buildings is focused on energy use impacts.

- Systems manual for building operators.
- Infiltration testing.
- Ventilation balancing and wattage measurement.
- Ducted heating/cooling balancing.
- Verification of envelope, air barrier, thermal bridge mitigation, and shading – that these are built to plans.
- Verification of lighting, mechanical, and process load systems per plans/energy model.
- Photo documentation, per [ENERGY STAR MFNC Photo Documentation Guidance](#).

The process will be based upon and comprehensive of USGBC's LEED requirements for basic level commissioning to support dual certification.

Provider requirements:

- Two projects experience, or

³⁰ Projects located outside of the United States, or in California or Alaska, will need to meet the same criteria, regardless of their configuration.

³¹ Nonresidential projects with a building permit date after July 1, 2021 will be required to follow the EPA Energy Star Multifamily New Construction Program Certification Criteria.

- Certification from CPMP, BCxP, ACG.

Commissioning procedures follow either:

- ASHRAE Standard 202 – 2013
- NEBB Procedural Standards for Whole Building Systems Commissioning for New Construction

3.6.3 Phius Certified Rater/Verifier Manual

Full document can be found in [Appendix E](#), below.

The manual contains:

1. Description of Phius Certified Rater and Verifier
2. Certification Eligibility, Requirements & Maintenance
3. Pre-Construction Requirements
4. Technical Inspection and Field Requirements
5. Post-Construction Requirements

3.6.4 Contractor Declaration

The intent of the Contractor Declaration is to have a written statement of proof that the as-built building conforms to the provided documentation and outlines any as-built variations from construction documents. This information will be verified through the site tests as performed by the Phius Certified Rater or Verifier.

Here are some sample wordings:

I, _____, as general contractor of the _____ (project) located at _____ (address), confirm that the documents supplied to Phius on _____ (date) are identical to the finished project.

Any discrepancies or changes are listed here: _____.

This declaration certifies that the _____ (project) located at _____ (address), has been constructed according to the technical specifications in the _____ energy model, which has been populated based on the drawings submitted on _____ (date).

There are no deviances from the file or any of the supporting documentations that have previously been submitted to Phius.

These declarations should be placed on an official letterhead and signed by the construction supervisor or general contractor. These wordings can be adjusted, but these are good examples to start from.

Phius Project Certification Steps

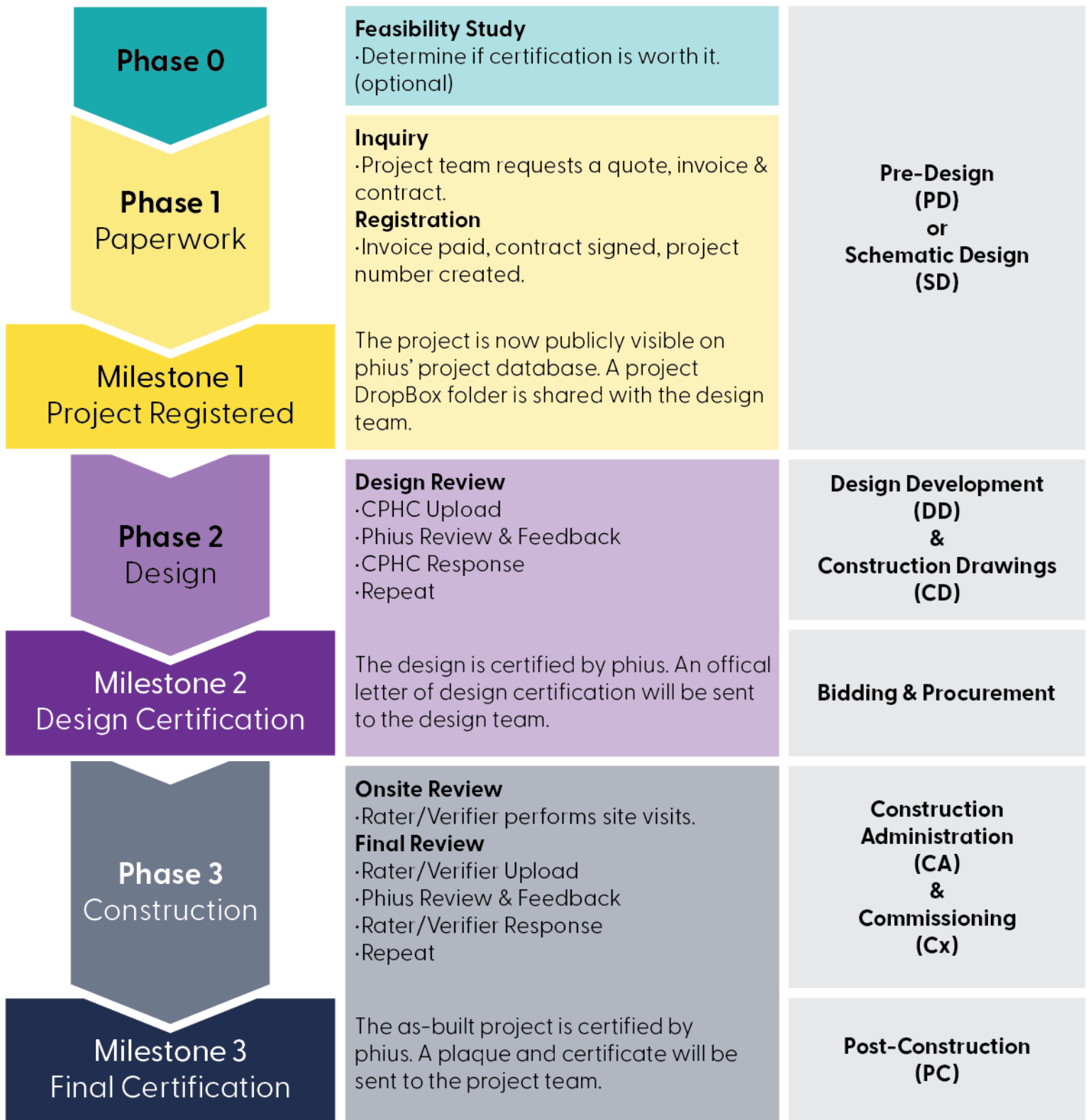

4. Process

4.0.1 Phase 0: Project Feasibility Study (Optional)

To help decide if Phius Certification is a worthwhile pursuit, project teams may request Phius to conduct a feasibility study.

- To review what is included and required to request such a study, visit this page: [Feasibility Study](#)
- Payment: Fee structure outlined in [Section 5.4.2](#). Make payment by check or request an invoice for online payment. All credit card transactions incur a 3% fee.

4.0.2 Phase 1: Paperwork

Review this Guidebook, which summarizes all requirements, covers energy modeling protocol, and includes vapor control recommendations and other technical details.

- Inquiry
 - Request a project quote, invoice and contract from the Submit a Project page.
 - Certification fees are outlined in [Section 5](#).
- Registration
 - Sign and return contract
 - Pay Invoice
 - Payments can be made:
 - By mail – send a check that includes the invoice number
 - By ACH/Wire Transfer – available upon request
 - By credit card – available upon request, all credit card transactions incur a 3% fee

4.0.3 Milestone 1: Project Registered

- A project is registered after the invoice is paid and the contract is signed.
- Phius will assign a project number and share a DropBox folder with the Submitter.
 - Reach out to Phius via email to invite other members of the project team to the folder.

4.0.4 Phase 2: Design

- Design Review
 - The Submitter/CPHC must upload project documentation into the appropriate subfolders within the DropBox.
 - The Submitter/CPHC must fill out the form under Phase 2: Design on the [Submit a Project](#) page to submit the project in the Project Certification Review Queue.

- Phius cannot begin a project review until both payment and an executed contract are received.
- [Section 4.1.1](#) shows the expected timeline for design review.
- The 'document upload required' date indicates the latest date that documentation may be uploaded and still allow Phius to meet the feedback return dates indicated.
 - Documentation uploaded after the 'document upload required' date may not be reviewed.
 - If insufficient documentation is provided, Phius will reach out to the submitter and the project will be pushed back two weeks in the review queue.
- After the review is complete, Phius will provide a Feedback Form in the project DropBox and notify the submitter via email.
- The Submitter/CPHC must reply to comments in the Phius Feedback Form and provide updated documents for review.
- The Submitter/CPHC must fill out the form under Phase 2: Design on the [Submit a Project](#) page to re-submit the project in the Project Certification Review Queue.
- Repeat.
 - Most projects undergo 3 rounds of design review but there is no limit to the number of reviews included for design certification.

4.0.5 Milestone 2: Design Certification

- Design Certification is awarded after the design feedback process is complete and the project meets all requirements.
 - Phius will send a Design Certification Letter to the Submitter/CPHC via email.

4.0.6 Phase 3: Construction

- Construction Review
 - During construction, the Phius Rater/Verifier must complete all of the on-site inspections and tests with various site visits.
 - The CPHC should update the WUFI Passive energy model to match any known as-built changes as well as final test results. All changes should be tracked in the Phius Certification Feedback form used during Design Certification.
- Final Review
 - The Phius Rater/Verifier must upload all documentation to the project DropBox after all on-site inspection and testing is complete.

- o The Phius Rater/Verifier must fill out the form under Phase 3: Construction on the [Submit a Project](#) page to re-submit the project in the Project Certification Review Queue.
 - [Section 4.1.1](#) shows the expected timeline for final review.
- o After the review is complete, Phius will provide a Feedback Form in the project DropBox and notify the Rater/Verifier via email.
 - Any inconsistency/request for documentation will be noted.
- o The Phius Rater/Verifier must reply to comments in the Phius Feedback Form, provide additional documentation and clarify where requested.
- o Repeat.
 - Most projects undergo 2 rounds of final certification review.
 - To shorten the final review process, the Phius Rater/Verifier should work closely with the submitter/CPHC.

4.0.7 Milestone 3: Final Certification

- If not adjusted by the CPHC, before final certification is awarded, Phius will adjust the final WUFI Passive energy model to match the verified results for:
 - Air-tightness test results
 - Average continuous ventilation rate
- Measured ventilation fan wattage.
- Certification is awarded after the final review process is complete and the project is meeting all requirements.
 - Phius will send a notification via email to the submitter/CPHC and Rater/Verifier including information to print certificates, plaques etc...
 - Purchase Phius Certified Project Plaque(s)
 - One plaque is included per project, additional are [available for purchase](#) for \$75.
 - If a project qualifies for Phius ZERO, an additional plaque is [available for purchase](#) for \$75.

4.0.8 Incentives

Updated local and national incentives can be found on [Phius' Incentives webpage](#).

- With the addition of a QA/QC process, Phius projects are now able to gain more performance-based incentives.
- Since 2013, Phius has partnered with the DOE's Zero Energy Ready Home program as well as ENERGY STAR for Homes. These programs are prerequisites for Phius Certification. Your Phius Certified Rater or Verifier will complete documentation for all these programs during their on-site visits, and the project will be awarded recognition from all three.

- Most projects will automatically receive a RESNET HERS Index score as part of certification. The RESNET HERS Index is the leading industry standard by which a home's energy efficiency is measured. Many local, state, and federal financial incentive programs require a HERS Index to demonstrate compliance.

4.1 General Tips During the Process

- When uploading new information, please also update the feedback form, so that we know what has changed. The feedback form is the primary communication channel. It covers all the bases, that is, it serves also as a checklist. It is a written record and keeps everything in one place to keep track of what was said by whom and when on each point.
- Communication by phone or email can be used from time to time, but these outside discussions should be captured in the feedback form.
- Likewise, when uploading new feedback, please give it a final run through to make sure that if you refer to new information, that those documents are in fact uploaded to the DropBox - and that the noted adjustments to the energy model were implemented.
- Include dates in the file naming conventions, and name the files in a logical manner (i.e. v1, v2, etc.). Please also avoid uploading a file that was arbitrarily assigned a file name that is unreadable/non-descriptive of the file content. Rename files when necessary, before uploading.
 - Ex: original file downloaded from online, file name 'k35fd8463yfh.pdf'. Rename to 'Dishwasher ES Rating.pdf'

From time to time, we may ask for changes to the energy model even if it looks like the change will probably have a small impact, or in cases where there are two mistakes, but the net result is a wash. There are two reasons for this:

1. Educational—on the next project it may make more of a difference and we do not want people to repeat mistakes.
2. Accuracy—improve the chances that the model will match actual energy use if the comparison is ever made.

4.1.1 Review Timeline

Generally, projects can expect the following review timeframes. These estimates are applicable to the Prescriptive & Performance paths.

| Round of Design Review | Document Upload Required | Feedback Returned |
|------------------------|----------------------------|---------------------------|
| 1 | 3 weeks before return date | 6-8 weeks from submission |
| 2 | 2 weeks before return date | 4-6 weeks from submission |
| 3 | 2 weeks before return date | 2-4 weeks from submission |
| 4 or more | At time of submission | 1-2 weeks from submission |
| <u>Expedite Review</u> | At time of submission | 1-2 weeks from submission |

| Round of Final Review | Document Upload Required | Feedback Returned |
|-----------------------|--------------------------|---------------------------------|
| Document | At time of submission | 5 business days from submission |
| 1 or more | At time of submission | 1-2 weeks |

The overall certification process timeline is highly variable and depends on the response time from both the reviewer and the submitter. It also depends on the completeness and accuracy of the first submission.

Expedite Review: An expedited review path may be available for an additional fee (See [Section 5.3](#)). Whether or not this option is available is up to the discretion of Phius and the volume of expedited reviews in the certification queue at the time of submission.

4.2 Phius Portal Access & Submitting a Project

All Phius trained professionals, certified professionals and Phius Alliance members will automatically have access to the [Phius Portal](#).

Projects should be submitted through the 'My Projects & Products' page using the 'Submit a Project' button. A six-digit [Phius ID](#) is required to submit a project.

- For individuals, who are not trainees, certified professionals or Alliance members that would like to submit a project for certification, a Project Submitter Profile must be created.
- Use [this form to create a Submitter profile](#). A Phius ID will be assigned to you and sent to you via email, and you will be granted access to the Phius Portal to submit a project.

Any questions regarding Phius Portal access should be directed [here](#).

4.3 DropBox Instructions and Tips

Creating a New Project

After a project has reached Milestone 1, Phius will create a DropBox folder for the project and invite the Submitter to the folder. If other members of the project team need to be invited to the DropBox folder, please inform Phius' Certification Manager.

A few important notes:

- The folder structure within the DropBox is organized for consistency between projects and allows Phius' Project Certifiers to find documentation quickly. Using the existing folder structure is strongly recommended.
- Uploading documents to the DropBox folder is not an indication to Phius that the project is ready for review. Project teams must submit the project into Phius' Review Queue as indicated in Phase 2.

4.4 Required Submission Documentation

Project Documentation: [Phius Single-Family Sample Project](#)

For Phius to begin a Project Review, the following documents need to be added to the DropBox:

1. Compliance Tool ([See 4.4.0](#))
2. Drawings

For Phius to award Design Certification to a project, the following documents must be added to the DropBox and approved by the Phius Certification team:

1. Compliance Tool ([See 4.4.0](#))
2. Drawings
 - a. Window and Envelope area takeoffs required for the Prescriptive path
3. Datasheets (or basis of design documents)
 - a. Fenestration
 - b. Systems (Ventilation, Heating/Cooling, Water Heating)

All other documentation must be added to the folders before Final Certification can be awarded.

The following does not need to be completed for Design Certification (though any additional information available should be uploaded):

- Airtightness Reports
- Ventilation Commissioning
- Contractor Declaration
- Photos
- Applicable Phius Certification Quality Assurance Workbook

4.4.0 Compliance Tool

| Path | Performance | Prescriptive |
|-------------------------|--|--|
| Compliance Tool | WUFI® Passive Energy Model (see Section 6.1.1) | Phius Checklist (v2.2 or newer) |
| Additional Notes | <p>Must be fully complete with all branches filled out and results populated.</p> <ul style="list-style-type: none"> The Design Certification review can begin without all final specifications developed for such items as appliance types or mechanical systems – but building envelope components should be specified for the first review. <p>If more than one ‘case’ is used in the WUFI Passive Energy Model:</p> <ul style="list-style-type: none"> Specify which case should be reviewed by adding ‘REVIEW’ in the case name OR Remove all cases that should not be used for certification review <p>If unspecified, Phius will review Case 1.</p> <p>Must be congruent with the rest of the submitted documentation.</p> | <p>Must be fully complete with all sections filled out.</p> <ul style="list-style-type: none"> The ‘Submittal’ column must be complete, identifying the location of the submittal that verifies compliance with the associated checklist item. Supporting calculations for compliance should be completed within the provided areas in the checklist. <p>Must be congruent with the rest of the submitted documentation.</p> |

4.4.1 Construction Drawings

The construction drawings should be submitted in .PDF format, show dimensions, and cover the following list of documents:

Design Drawings:

- Plans
- Sections
- Elevations

Detailed Drawings

- Show all unique junctions of the thermal envelope.
 - o Exterior and interior wall junctions to the basement floor or slab.
 - o Exterior junctions to roof or ceiling.

- o Junctions between wall and intermediate floors.
- o Window installation conditions (including reveal dimensions).
- o Any exterior anchoring systems for balconies or awnings.

Airtight details

- o Window installations
- o Building component connections
- o Penetrations
- All details must be fully annotated with dimensions and callouts for specific materials.
 - o e.g. call out insulation type rather than noting 'rigid' so the insulation type can be matched with the insulation specifications provided, and thermal resistance can be verified.
- Airtight details must be comprehensible and show a continuous uninterrupted barrier that forms from the different materials and components at all junctions.

Thermal Envelope

- Must be clearly identified. Best accomplished using section or elevation drawings with exterior dimensions
- Thermal bridges need to be called out and calculated when applicable.
 - o The PHIUS reviewer will look for continuous and consistent insulation in all details and flag any details that need to be calculated.
 - o Submit both THERM files and psi-value calculation for any thermal bridge details calculated.

Mechanical Drawings

Mechanical drawings need to show:

- Ventilation
 - o Duct layout and sizes
 - o Supply and extract airflow rates at each diffuser and the diffuser location
 - o Soundproofing, filters, pressure overflows
 - o Outdoor penetrations for exhaust and supply ducts
 - o Duct insulation thickness and type
 - o Supply and exhaust duct length from the inside of the exterior wall to the ventilation unit
- Heating and Cooling
 - o Location of elements - both point source and supply air
 - o Size/capacity of elements
 - o For incentives Manual J/D calculations or dynamic simulation may become necessary.
- DHW System
 - o Type of tank(s) and system
 - o Comprehensive length of the DHW pipe length calculation as described in the energy modeling protocol section of this Guidebook (see [Section 6.10.2](#)).
- Additional systems (solar thermal, defroster, ground loop, earth tube, etc.)

4.4.1.1 Ventilation Calculations

- Gross Building Volume
 - Total enclosed volume of the building.
 - Uses exterior dimensions, to the edge of the thermal boundary to calculate.
 - WUFI Passive can reasonably calculate this. It is acceptable to choose 'From visualized volume and components'
- Net Volume
 - The real interior building volume
 - Total volume within the building envelope - drywall to drywall, floor to ceiling
 - WUFI Passive can reasonably calculate this. It is acceptable to choose 'From visualized volume and components'

4.4.1.2 Site Plan

Needs to show:

- The building's orientation.
- Changes in topography (if applicable).
- The location and height of neighboring buildings or structures.
- The location and height of trees or ground levels that cast lateral shadows.

The site plan and site shading photos together must show the complete shading situation. If necessary, other drawings should be included.

4.4.1.3 Site Shading

Phius requires a shading study on the project site. Refer to [Section 6.5.3.5](#) for modeling protocol. Any combination of the following documentation is acceptable:

- Site plan with clearly marked shading obstructions and annotations noting height and distance from the building. The site plan should include all obstructions that would reasonably shade the building.
- Sky-dome or sky-panorama images* for each facade with overlaid measurement grids.
- Solar pathfinder images* for each facade.
- Solmetric images* for each facade.

*Images provided should be clearly labeled, indicate the direction the image is facing and include an accompanying site plan indicating the location the images were taken.

4.4.1.4 Interior Conditioned Floor Area (iCFA)

iCFA is the interior-dimension (drywall-to-drywall) projected floor area of the conditioned spaces with at least seven feet ceiling height. It includes stairs, cabinets, interior walls, mechanical spaces, storage, but excludes open-to-below.

More specifically:

- Include the floor area of interior spaces at least 7' in height, measured from the interior finished surfaces that comprise the thermal boundary of the building. Spaces that are open-to-below shall not be counted. (The general concept is "walkable").

- Other than open-to-below, the projected floor area of all spaces within this shall count toward the iCFA measurement, including walls, cabinets, mechanical spaces, storage, etc.
- Projected floor area of the stair treads counts toward iCFA on all floors, that is, once per floor. (By the 7' height rule, some floor area under the stairs on the 1st floor would be excluded. This conflict is resolved by including it).

Naming Conventions

Phius has not dictated strict naming conventions. However, naming conventions should be included for all windows and areas. These should be clearly labeled and easily understood by a reviewer unfamiliar with the project. The best way to do this is to label the drawing and have the labels in the drawings match the labels used in the Energy Model. There should be enough overlap in the names such that each window and door can be positively identified. Often, following a logical rotation (such as clockwise) is helpful. A copy of the drawing set that is annotated specifically for Phius Certification is extremely helpful and preferred. All penetrations should be listed.

Formats and Sizes

Phius does not dictate drawing scales though they should be large enough to be comprehensive and readable. PDF is the preferred drawing file format. Phius respects the intellectual property right you have for your details and drawings. This concern should not inhibit the sending of drawings, specifications, or other documentation. Remember that comprehension of a project by an outside party (Phius) is the goal. The easier it is to understand a project the quicker and less costly the certification will be for all parties involved.

4.4.2 Technical Specifications

- Data sheets and performance specifications are necessary for all values input into the energy model.
- Generally, these should be provided by the product manufacturer. For some components and equipment, third party ratings are provided. More details on each component/system found under [Section 6: Energy Modeling Protocols](#).
- This should include documentation from third party agents including shading calculations, appliance energy usage, earth tube efficiencies, and any other exteriorly derived values.
- It is best to have this information available and formatted ahead of the Design Certification process.

The following Sections: 4.4.3 - 4.4.8 must be submitted for final certification along with any updates to Sections 4.4.1 and 4.4.2.

See [Appendix E: Phius Certified Rater/Verifier Manual](#) for full details.

4.4.3 Pressure Test Verification

- Must be performed by an approved Phius Certified Rater/Verifier.
- Must be a multipoint test of both pressurization and depressurization.

- The final result is the average of pressurization and depressurization.
- See [Appendix F](#) for test protocol details.

4.4.4 Ventilation Commissioning

Will be completed by an approved Phius Certified Rater/Verifier and should include the following information:

- Description and location of the project.
- Name and address of the Rater/Verifier.
- Time and date of commissioning.
- Manufacturer and model number of ventilation unit.
- Adjusted volumetric flows per diffuser - both supply and exhaust.
- Flow comparison between supply and exhaust airstreams as measured between the unit and the exterior, or the interior before any branch ducts (imbalance <10%).
- Power draw of the ventilation unit at nominal speed.

4.4.5 Declaration of the Construction Supervisor

- See [Section 3.6.4](#) for an example.

4.4.6 Photograph Documentation

- Exterior photos of each façade and surrounding site.
- Representative photos of the various insulated assemblies, window and door installs.
- Representative infrared photos, inside and outside.
- Documentation for the construction is also acceptable.

4.4.7 Additional Documentation

- Examples could be shading studies, extra calculations, system sizing, ground loop calculations, etc.
- See [Section 6.1.5](#).

4.4.8 QA/QC Reports

- Supplied by the Phius Certified Rater or Phius Certified Verifier, see [Appendix E, Section 4.3](#) for more details.
- Available to both the project submitter and Phius.
- Submitter is able to update the energy model and documentation based on reports.

4.5 Phius Certification Feedback Document

The Phius Certification Feedback Document is one of the main channels of communication between Phius and the project submitter. The document is used to track the design certification progress and includes feedback on the energy model, the drawings submitted, and specifications submitted. **This document must be uploaded to your project's designated DropBox Folder for each round of review.** When the submitter makes changes to the Phius Certification Feedback Document, the updated energy model should also be uploaded.

Any external communication via email, phone call, etc. must be copied into this feedback form so the project reviewer is aware.

4.6 Certified Project Database Listing

Projects appear in the Phius Certified Projects Database after the project is registered in the system.

4.6.1 Editing Your Listing

Project editing can be done through the Phius Portal (see Section 4.2), under the My Projects & Products tab.

- Phius is responsible for filling in all data shown on the 'Phius Project Data' tab of the portal.
- The project team is responsible for entering the data for all of the remaining tabs that appear in the project listing.

4.6.2 Adding Photos

Photos must be submitted by the project team through the [Phius Portal](#), My Projects & Products page, EDIT page, Photos tab.

5. Phius Project Certification Fee Schedule

Phius quotes a single fee for the full certification review process, rather than a separate fee for design certification and final certification.

Phius' quoted fees do not include the cost of the 3rd party QA/QC visits and on-site testing, which are determined by the Phius Certified Rater/Verifier of choice, see [Section 3.6](#).

5.1 Performance Path Certification Fee

Certification fees are based upon the project's calculated square feet of iCFA (interior conditioned floor area). If a project consists of residential and significant non-residential spaces, two energy models may be necessary, and pricing may be based on each model individually.

| PERFORMANCE PATH | | | | | | | |
|-------------------------|--|---------|----------|----------|----------|----------|----------|
| | Estimated Rates* – <i>Varies based on iCFA</i> | | | | | | |
| iCFA (ft ²) | < 4,500 | 10,000 | 25,000 | 50,000 | 100,000 | 250,000 | 500,000 |
| Single-Family | \$2,200 | | n/a | | | | |
| Multifamily* | \$2,750 | \$5,250 | \$11,275 | \$17,775 | \$25,975 | \$37,775 | \$52,225 |
| Non-Residential* | \$2,200 | \$4,900 | \$10,475 | \$15,525 | \$21,450 | \$32,400 | \$45,075 |

All single-family projects have a fixed fee of \$2,200 regardless of project size. Other projects up to 4,500 square feet of interior conditioned floor area (iCFA) also have a fixed price as shown above. Projects larger than 4,500 square feet require a custom quote. Request a quote using the link under Phase 1 on the [Submit a Project page](#).

**Pricing noted above in effect as of July 1, 2023. Projects with contracts or quotes from before this date are not subject to the updated fees.

5.1.1 Discounts

- Phius Alliance Members receive a 15% discount, up to \$600.
- Non-Profit Organizations are eligible for a 25% discount, up to \$1,000.
- Duplicate/repeating projects may receive a discount for each duplicate submitted after the first.

5.2 Prescriptive Path Certification Fee

Certification fees are flat rate, based on project type as outlined in the table below.

| PRESCRIPTIVE PATH | |
|------------------------|---|
| Single Family Detached | Townhouse / Single-Family Attached |
| \$1,000 | \$1,000 per unique dwelling unit \$750 per duplicate unit type |

5.3 Expedite Fees

An expedited review may be available for an additional 50% up-front cost on the base fee (i.e. a single-family home with a base fee of \$2,200 would have an expedite fee of \$1,100, totaling to \$3,300 for the full fee). See details in [Section 4.1.1 Review Timeline](#).

5.4 Additional Consulting

Phius can provide additional services, such as opaque assembly hygrothermal analysis, thermal bridge moisture risk analysis, thermal bridge calculations, red-flag reviews, and feasibility studies. Performing this type of analysis is not included in the project certification fee and is available for an additional fee as needed. Typical consulting rates are noted below, but specific services may have different pricing.

Base Consulting Rate: \$200/hr

Phius Alliance Member Consulting Rate: \$175/hr

5.4.1 Red-Flag Review

Phius offers red-flag reviews to provide preliminary feedback on projects interested in Phius Certification. This service is primarily geared towards project teams that have created a WUFI-Passive energy model and are seeking high-level review of documentation available to get

a sense of if the project is on the right track to move forward with design. Feedback for red-flag reviews is provided in an excel document that follows the same format as the typical Phius Certification feedback form.

- **Timeframe:** Generally completed in two hours of review time and only covers high-level information. Feedback is provided to the client within 5-10 business days of submission.
- **Goal:** Provide project teams with feedback related to the most important design elements that may affect a project early in the design process.
- **Review Items:** Red-flag reviews concentrate on feedback related to the documentation outlined below (if available).
 - Climate, Phius space conditioning targets, building altitude, and building orientation are reviewed.
 - Foundation type is reviewed.
 - Opaque assemblies
 - Hygrothermal risk reviewed with Phius' prescriptive moisture requirements.
 - Transparent assemblies
 - Comfort & Condensation risk reviewed with Phius' prescriptive requirements.
 - Thermal Bridges
 - Potential thermal bridges are identified.
 - Internal Loads / Occupancy
 - Appliances not reviewed in detail, but types of appliances are reviewed (eg. exhaust dryer vs condensation dryer)
 - Phius lighting & MELs are not reviewed in detail, but general comments are made if calculations are inconsistent or vary from typical conditions.
 - Mechanical Ventilation
 - High level ventilation patterns reviewed; room-by-room ventilation not reviewed in detail.
 - Bathrooms & kitchens reviewed for compliance with Phius minimum average ventilation rates.
 - Mechanical Systems
 - High-level review of planned systems
 - Feedback provided on systems, devices or additional energy use that may not be accounted for
- **Fee:** Follows general consulting pricing listed above.
- **Request a Red-Flag Review:** [Review this link](#) and [Contact Us](#).

5.4.2 Feasibility Study Fee

Feasibility study fees are based upon the project's type (residential or commercial) and calculated square feet of iCFA (interior conditioned floor area). If a project consists of residential

and significant non-residential spaces, two energy models may be necessary, and pricing may be based on each model individually.

| FEASIBILITY STUDY* | | | | |
|------------------------------|--------------------|---------------------|----------------------|-----------------------------------|
| iCFA (ft²) | < 10,000 | Up to 50,000 | Up to 100,000 | For each additional 50,000 |
| Residential | \$1,500 | \$2,500 | \$3,000 | +\$500 |
| Non-Residential | \$2,000 | \$3,500 | \$4,000 | +\$500 |

*Discounts may be available for project teams that provide a SketchUp model ready for import into WUFI Passive. Discounts are subject to Phius’ definition of ‘ready’ and may not be applicable if significant revision is needed by Phius.

**Pricing noted above in effect as of July 1, 2023. Projects with quotes from before this date are not subject to the updated fees.

5.5 Certification Plaque

One complimentary certification plaque is included per certified building. Additional plaques can be [purchased](#) at a cost of \$75/each.

6. WUFI® Passive Energy Modeling Protocol

6.1 Getting Started

Note that all requirements below pertain to only projects pursuing the Performance path. A WUFI Passive energy model is not used for verifying compliance with projects pursuing the Prescriptive path. The approved compliance tool for the Phius Prescriptive path is the Phius Prescriptive Checklist as noted in [Table 4.4.0](#).

6.1.1 Accepted Modeling Software

For Phius CORE 2021 & Phius ZERO 2021:

WUFI Passive: Version 3.3.0.2

WUFI Passive Free: Version 3.3.0.2

For Phius CORE Prescriptive 2021:

Phius CORE Prescriptive 2021 Checklist: Version aligns with [Table 4.4.0](#)

6.1.1.1 General Recommended WUFI Passive Settings

| Options | General | Dimensions, visualized geometry | Outer, extern partitions not included. |
|---------|-----------|---------------------------------|---|
| Options | Usability | Tool tips | Check all boxes to ensure the proper hover-over hints are visible. |
| Options | Usability | Data Recovery | Turn this on to auto-save projects. |
| Options | Usability | Comments | Use this to save notes within each screen of your project file. Helpful for colleague, reviewer, personal notes, etc. |
| Options | Usability | Show edit icons in tables | Select to view cells with built-in calculators. Will appear with [...]. |
| Options | Usability | Show project/case in footnote | Select to include case name in footer of printed results reports. |
| Options | Passive | Default Certificate Criteria | Set to Phius 2021 |

6.1.1.2 WUFI Passive Online Tutorials

Free online tutorials can be found here:

<http://www.Phius.org/Phius-certification-for-buildings-products/wufi-passive-tutorials>

6.1.1.3 Project File Versions

Older project files can always be opened in newer versions of the software, but newer files generally cannot be opened in older versions.

Sometimes*, a project file can be opened in a previous version of WUFI Passive. To do this, save the file type as 'XML' in the newer version WUFI Passive, then open the XML file in the older version.

i.e. A project file created in WUFI Passive 3_3_0_2 cannot be opened in 3_2_0_1.

A project file created in WUFI Passive 3_2_0_1 can be opened in 3_3_0_2.

**It is not guaranteed that files created in "intermediate" or test versions of WUFI Passive can be opened in future release versions.*

6.1.1.4 Dynamic modeling in WUFIplus

Though not required for certification, consider also doing dynamic modeling (WUFI Plus) when:

- Cooling and/or moisture loads are high.
- Heating is discontinuous (during the heating period).
- Occupancy and indoor conditions vary considerably.

- Comfort and overheating should be assessed.

If dynamic modeling seems called for, Phius suggests running a 3-zone dynamic model as a comfort analysis using WUFI Plus (WUFI Passive dynamic side), or another dynamic energy model. The 3 zones would be the coldest room, warmest room, rest-of-building. There are two possible approaches – one is to set the heating and cooling system capacities very high and look for the per-square-foot differences in the heating and cooling loads among the zones. The other is to limit the system capacities and look for failure to maintain the desired interior temperature set-points.

6.1.2 Climate Data

- Must be approved by Phius for each project.
- It is important to choose the correct dataset, especially given that a project's space-conditioning performance targets vary by location.
- Phius has generated 1000+ climate datasets for locations around the United States; they are available as individual XML database import files for each state, as well as a single XML file for the entire United States. These datasets are available free to Phius Alliance members and can be downloaded from the [Phius Alliance Member Resources](#) page.
- A custom data set is required for a project location when the closest existing data set is more than 50 linear miles and >400' different in elevation from the project location.
 - o Project locations even within the parameters above might benefit from custom climate data.
 - o The cost of a custom climate data set is \$75 and may be purchased on the [Phius Climate Data](#) page.
- If a project is within 50 linear miles and within 400 feet difference in elevation of an existing climate data set, you must use the Phius space conditioning targets associated with the existing data set. However, you can order custom climate data if you would like to.

6.1.3 Energy Model Defaults

The accepted software versions agree on default input values for several input parameters. Unless otherwise noted below, these values should be used in the energy model for certification. These values (and the way they are calculated) may be updated in the future to coincide with research and best practices.

6.1.4 Energy Model Inputs Requiring Additional Documentation

- Ground Thermal Resistivity > 0.1 hr.ft².F/BTU.in.
- Window frame-to-wall psi value < 0.015 BTU/hr.ft.F
- Subsoil heat exchanger efficiency > 60%.
- Air change rate for window ventilation; see [Section 6.7.3](#).
- Solar fraction for hot water – expert/specialist calculation recommended if greater than 65% estimated to be covered by solar in WUFI Passive model.

6.1.5 External Calculators & Protocol Documents

Many external calculation methods and protocol documents are developed as new modeling situations arise. Eventually, these calculation methods and protocols are built in or implemented into the WUFI Passive energy modeling tool. External calculators may be used in the interim.

- Always download the latest version of the protocol documents on the [Calculators & Protocols page](#).

6.1.6 WUFI Passive Cases

WUFI Passive allows for quick creation of multiple 'cases' within a single project file. Cases are generally created by duplicating a previous case. This can be used to compare alternate designs and provides direct result comparison. Cases can contain varying geometry, and a new geometry file can be imported into a duplicate case.

For Mixed-Use projects, it is helpful to import the whole building as two zones (residential and non-residential). Then, one case can cover the residential portion as the 'active' or 'simulated zone', and the second case can cover the non-residential portion as the 'simulated zone'. This keeps the entire building in one WUFI Passive model.

6.1.7 Using SketchUp with WUFI Passive

For guidance, tips and tricks on using WUFI Passive in tandem with SketchUp and for other general modeling guidance review the Guidelines for using Sketchup with WUFI Passive [here](#).

6.2 Localization/Climate

Selecting a Climate Data Set - See [Section 6.1.2](#).

Download and save a Phius Climate File or Phius Climate XML Database - See [Section 6.1.2](#).

6.2.1 Localization

To Upload a Phius Climate File into WUFI Passive

Select "User Defined" from the dropdown list, click the "Browse" button, and search for the saved climate file. Change the file type in the bottom right hand corner to "Excel (.xls)" if need be. Or, complete a one-time download of the climate database XML file to your WUFI Passive database. This can be done by selecting "Database", then selecting the drop down menu to "Import from XML File". These files are also available on the [Phius Alliance Member Resources](#) page. After this import, you will be able to browse your WUFI Passive database to select a climate dataset for your new project.

*Please note climate data import is not available in the free version of WUFI Passive; in this version the climate data must be input manually. See guidance below, [Section 6.2.1.1](#).

About the Design Temperatures in the Climate Data

A super-insulated structure responds more slowly to outside conditions, so the peak loads are

moderated. The static mode calculation does also assume a slightly wider comfort range on the inside, 68-77 F instead of for example the Building America default 71-76 F, and similarly, the reason for this is that the inside surface temperatures should be more stable, so the air temperature can vary a bit more and still be comfortable, because the radiant temperature of the surfaces varies less.

We recommend against taking the passive mode design temperatures and using them in an ACCA manual J calculation, but rather run each method on its own terms and compare the bottom line Btu/h results.

Altitude Building: The altitude of the project site must be input. Site altitude may be verified using Google Earth.

Phius recommends locating the project site on Google Earth, placing a 'marker' on the site at ground level, and providing a screenshot verifying site altitude. This should be uploaded in the Site Plan/Shading folder.

Time Zone: This entry is required for the dynamic shading calculation. Use standard time, not daylight.

- Eastern Standard Time: UTC -5
- Central Standard Time: UTC -6
- Mountain Standard Time: UTC -7
- Pacific Standard Time: UTC -8
- Alaskan Standard Time: UTC -9

Climate Zone: Should be set to align with the climate dataset used for certification. The climate zone is used to determine the utilization for Phius CORE projects that employ on-site renewable energy.

Ground Thermal Conductivity: In heating dominated climates, this value may not be lower than 0.833 (BTU/hr.ft.F), and should usually be left at the default of 1.1558 (BTU/hr.ft².F).

For thermal resistance, this is equivalent to no more than 0.1 R/in (hr.ft².F/BTU.in).

6.2.1.1 Entering climate data into WUFI Passive Free

| US CUSTOMARY: | | | | | | | | | | | | | Heating Load | | Cooling Load |
|--------------------------|----------|------|------------------|-------|---------------|-------|------|--|------|----------------|-------------------------------|------|--------------|------------------------|--------------|
| Month | 1 | 2 | 3 | 4 | 5 | 6 | 7 | 8 | 9 | 10 | 11 | 12 | Weather 1 | Weather 2 | Radiation |
| Days | 31 | 28 | 31 | 30 | 31 | 30 | 31 | 31 | 30 | 31 | 30 | 31 | | | |
| CHICAGO DBARE INTL AP 11 | Latitude | 42.0 | Longitude * East | -87.9 | Altitude (ft) | 659.4 | 0 | Daily temperature variation summer (F) | 18.7 | Radiation Data | kBTU/(ft ² .month) | | Radiation | BTU/hr ft ² | |
| Ambient Temp (F) | 23.7 | 27.5 | 33.8 | 50.0 | 59.9 | 70.0 | 75.4 | 73.2 | 64.6 | 51.8 | 40.5 | 25.3 | 7.5 | 21.2 | 80.8 |
| North | 8.7 | 10.1 | 12.0 | 12.7 | 18.1 | 20.0 | 19.7 | 15.5 | 11.1 | 3.5 | 0.3 | 7.0 | 11.4 | 11.4 | 20.2 |
| East | 17.4 | 21.9 | 27.9 | 31.1 | 40.3 | 46.6 | 39.9 | 35.5 | 31.4 | 24.1 | 15.2 | 12.8 | 35.8 | 35.5 | 45.7 |
| South | 30.7 | 31.4 | 32.3 | 26.6 | 28.2 | 24.7 | 27.6 | 28.5 | 31.4 | 33.0 | 24.4 | 27.9 | 67.2 | 23.8 | 43.1 |
| West | 11.7 | 14.6 | 17.8 | 20.6 | 21.3 | 27.6 | 28.5 | 24.4 | 19.0 | 14.3 | 8.6 | 9.8 | 19.7 | 13.6 | 42.8 |
| Global | 12.1 | 21.8 | 33.0 | 43.2 | 57.7 | 59.0 | 58.9 | 49.8 | 39.0 | 27.3 | 16.8 | 14.3 | 27.6 | 20.1 | 93.1 |
| Dewpoint | 15.1 | 17.2 | 22.0 | 33.0 | 35.4 | 43.7 | 45.9 | 40.2 | 31.0 | 22.7 | 15.3 | | | | |
| Sky temperature | 16.2 | 19.3 | 27.9 | 37.6 | 49.2 | 57.0 | 57.6 | 47.6 | 36.1 | 23.4 | 14.4 | 11.4 | | | |

| Speed setting | Jan. | Feb. | March | April | May | June | July | Aug. | Sept. | Oct. | Nov. | Dec. | Heating W. 1 | Heating W. 2 | Cooling W. 1 | Cooling W. 2 |
|---------------------------------|------|------|-------|-------|-----|------|------|------|-------|------|------|------|------------------------------|--------------|--------------|--------------|
| Data: User defined | | | | | | | | | | | | | | | | |
| Temperature [°F] | | | | | | | | | | | | | | | | |
| Ambient 1 | | | | | | | | | | | | | | | | |
| Dew point 3 | | | | | | | | | | | | | | | | |
| Sky* 4 | | | | | | | | | | | | | | | | |
| Ground* | | | | | | | | | | | | | | | | |
| Solar radiation [kBtu/ft²Month] | | | | | | | | | | | | | Solar radiation [Btu/hr ft²] | | | |
| North | | | | | | | | | | | | | | | | |
| East 2 | | | | | | | | | | | | | | | | |
| South | | | | | | | | | | | | | | | | |
| West | | | | | | | | | | | | | | | | |
| Global | | | | | | | | | | | | | | | | |

* Optional input. Sky/Ground: if not defined, temperatures will be estimated)

6.2.2 Space Conditioning Target Data

Use the [Phius 2021 Performance Criteria Calculator v3](#) to determine project specific space conditioning criteria.

General Inputs apply to all building types.

- o Envelope Area: Building exterior envelope area, including partitions to adjacent non-certified spaces or buildings.
 - The envelope area can be calculated manually or found in the WUFI Passive model under the results report or visualized components branch.
- Interior Conditioned Floor Area (iCFA): The total iCFA of the building. iCFA is defined as the interior-dimension (drywall-to-drywall) projected floor area of the conditioned spaces with at least seven feet ceiling height. It includes stairs, cabinets, interior walls, mechanical spaces, storage, but excludes open-to-below.

Residential Mode should be used for certification of all residential type buildings: single-family detached, single-family attached and multifamily buildings, excepting hotels and motels.

- Dwelling Units: The total number of dwelling units in the building.
- Total Bedrooms: The total number of bedrooms in the building.
 - Studio apartments are counted as '0' bedrooms.
 - Input all bedrooms, not number of bedrooms per dwelling unit.

Non-Residential Mode should be used for certification of all non-residential building types.

- Design Occupancy: Maximum occupancy of the building.
- **Custom Optimization**: For unique non-residential buildings with very high internal loads, ventilation loads, or highly variable occupancy, custom

optimization may be needed to determine the appropriate targets. This will be done on a case-by-case basis. An additional certification fee will apply.

Mixed-Use building types currently require two separate calculations to represent different use types.

Retrofit building types should review [section 1.5.6](#) and the associated allowance calculator.

6.2.3 Source Energy/CO2-Factor

Source Energy Factor for Grid Electricity

Use the national average value for certification, regardless of regional differences. Use V3.3.0.2 of the software or update the Source Energy Factors within WUFI Passive as outlined in this [Phius 2021 Modeling Update for WUFI Passive](#) document.

- USA: 1.8³²
- Canada: 1.96
- Japan: 2.77

This policy forestalls the tendency for “rebound effect” - of building designers taking advantage of locally “cleaner” grids to use more energy, and instead, in effect, shares that benefit with designers in “dirty grid” regions. This is consistent with the idea that with the current fossil-dominated primary fuel mix, energy impact translates into atmosphere impact.

6.3 PH Case

6.3.1 PH Case - General

The interior temperature thresholds for Phius Certification are 68F and 77F. Please contact Phius if the program of the project requires a different temperature set point.

Indoor Temperature defined on this tab is the ‘heating setpoint’, 68F should be used.

6.3.1.1 Occupancy and Internal Heat Gains

For residential projects, model occupancy as the # of bedrooms + 1. This is per unit if there are multiple units.

A bedroom is defined as per RESNET: [³³]

A room or space 70 square feet or greater, with egress window and closet, used or intended to be used for sleeping. A "den," "library," "home office" with a closet, egress window, and 70 square feet or greater or other similar rooms shall count as a bedroom, but living rooms and foyers shall not.

³² This value is reflecting a 2050 outlook, see [Appendix I-2.1](#).

³³ RESNET, op. cit., Appendix B

Exception: For dormitory buildings, occupancy is determined by the number of beds. Where the number of beds is equivalent to the number of occupants.

Internal heat gains are set “calculated”, rather than using a default value by building type.

6.3.1.2 Non-permanent occupants in multifamily buildings: Visitors and Workers

Source Energy Allowance:

Workers: Non-Resident workers such as office workers, senior/medical service workers, etc. will add to the planned occupancy load of the building. Schedules and number of workers should be summed and equated to full time occupants. For example, 3 workers that work 8 hours/day each can equate to 1 full time occupant. The number of equivalent full-time workers can be added to the residential occupancy and given the residential source energy allowance per person.

Visitors: If the building includes designated spaces that serve the residents as well as outside visitors, the commercial building source energy allowance per square foot should be applied to those spaces.

Internal Heat Gains + Energy Use:

Workers: By adding full time equivalent occupancy for workers into the total occupancy count, internal heat gains and other energy use is appropriately accounted for with no additional input.

Visitors: Depending on the nature of the typical visits (games, dinner, etc), the appropriate energy use of the visitors should be estimated and documented for design certification review

6.3.1.3 Number of Units and Floors

Number of Units: This is used to calculate the reference quantity for refrigerator and freezer entries, as well as calculating the DHW tap openings per year.

Residential: The total number of residential units should be used. At minimum, a ‘unit’ includes a kitchen, bedroom/living space, and bathroom.

Non-Residential: Enter 1.

Number of floors: The number of floors should be entered. This is used to determine:

1. Air-tightness allowance adjustment, if applicable.
2. Number of floors to be used for the DHW distribution losses when using ‘floor method’.

6.3.2 PH Case - Additional Data

Overheating temperature threshold: This entry is the cooling setpoint. For most cases, 77F should be used for certification.

Fresh Air Per Person: 15 cfm minimum required for residential (18 cfm recommended and default in WUFI Passive), 9-12 cfm for school and daycare, 35 cfm for sports halls.

Hot water tap-openings per person per day: Defines how many times each DHW tap is opened per person, per day. Used to calculate DHW distribution losses **only** when using the 'Simplified Individual pipes' method for DHW individual pipes.

Residential: This entry will not apply for Phius 2021 projects. DHW Distribution calculation method cannot be 'Simplified Individual pipes' for design certification.

Non-Residential: A user defined value may be input here based on total occupants assumed on an average day in the building, the total number of tap openings, and

Infiltration/Airtightness: Per [Section 3.1.3](#)

For buildings of five stories and above that are also of noncombustible construction:

q50 <= 0.080 CFM₅₀/ft² of gross envelope area

For all other buildings:

q50 <= 0.060 CFM₅₀/ft² of gross envelope area

Gross envelope is measured at the exterior of the thermal boundary, the same as for the energy model, and includes surfaces in contact with the ground.

Envelope airtightness at 50 Pa: Phius recommends entering the maximum limit for the building here. A lower value may be used to meet space conditioning targets, but the designer must acknowledge that the lower value must be met in the field for the project to pass at final certification.

Note: For some large buildings with elements that are considered non-threatening leakage ([Review Appendix F-2](#)), modeling with a higher airtightness value than the durability requirement noted above may be beneficial to ensure that the project passes the space-conditioning and source energy requirements with the un-taped blower door test value.

Non-Combustible Materials: Check this box if the building is of non-combustible construction. If this box is checked, and the building is 5 stories or greater (input on PH Case>General), the 'target' air-tightness will be adjusted in the model and report.

Example project conversion from cfm50/ft² to ACH50:

Total envelope area = 6,958 ft² & Net volume = 19,387 ft³

$$6,958 \text{ ft}^2 * (0.05 \text{ ft}^3/\text{min})/\text{ft}^2 * (60 \text{ min}/\text{hr.}) * (1/19,387 \text{ ft}^3) = 1.08 \text{ ACH50}$$

Maximum Humidity Ratio (if dehumidification is planned)

The default value of 0.012 lbw/lba should not be changed for Phius Certification. It is the upper limit for humidity levels according to the comfort standard ASHRAE 55-2004. This is essentially a humidity set-point. At 77 F this value corresponds to approximately 60% relative humidity.

Domestic Hot Water Use Per Person

- Residential: 6.6 gal/person/day
 - o Default is used for residential certification regardless of entry in WUFI Passive.

- Non-residential: 3.2 gal/person/day
 - o The default above will not fit for all non-residential projects. The entry may vary from the default if supporting documentation/calculation is provided and approved by Phius.

This input pertains to showers, hand-washing, and shaving. Laundry and dishwashing is separate from that, and calculated with the appliance entries. If there is no dishwasher, consider adding extra gallons to this daily value.

Remember, these are “hot gallons” (140 F). It calculates the energy to raise the water from the incoming water temperature (default 50 F) to 140 F, a 90 F rise. When mixed down to a temperature a person would want to shower under, it goes almost twice as far in terms of volume.

Cold Water Supply/Incoming Temperature

If this input is left blank in WUFI Passive, it will be calculated using an average annual ground temperature.

A user defined entry may be used if supporting documentation is submitted to confirm the new groundwater temperature. The adjusted groundwater temperature generally should not exceed the average ambient air temperature for the project’s climate.

Mechanical Room Temperature

The default value here is 68F. If the mechanical ventilation device (ERV or HRV) is located within the thermal envelope, this default should remain. If the ERV or HRV is located outside of the thermal envelope (eg. the roof), this value should be calculated using the ‘ERV_HRV Outside’ calculator which can be downloaded from the [Resource Library](#).

6.3.3 PH Case - Foundation Interface

Up to 3 different foundation interface connections can be defined. These determine reduction factors to be applied to components with ‘Ground’ assigned on the Outer Side.

Floor Slab / Floor Ceiling Area

For heated basements, only include the interior floor area. For all other ground conditions, include the entire floor area calculated to the exterior of the thermal boundary.

Floor Slab Perimeter

For heated basements, only include the interior perimeter. For all other ground conditions, include the entire (exterior-adjacent portion of the) floor slab perimeter measured at the exterior of the thermal boundary.

6.4 Zone 1

6.4.1 Visualized Volume

This value is not used for the “Passive House Verification” calculation; it refers to the volume of the visualized 3D model. This will be equal to the gross volume in most cases (when the model is drawn to the exterior dimensions).

6.4.2 Gross Volume

This volume represents the volume of the building measured from the exterior boundary of the thermal envelope. Generally, this is the same as the visualized volume. However, if objects are included in the 3D geometry that are not part of the thermal boundary, for shading, etc., the visualized volume may not represent the gross volume. In this case, the gross volume may be calculated, but it is not required.

6.4.3 Net Volume

The net volume does not affect the results of the energy model and is not required for certification. It can be used as an indicator of how many mechanical air changes are provided for the building and can be a useful metric. If a calculation is done, determine the home’s interior volume (drywall to drywall floor to ceiling, wall to wall) minus volume taken up by interior walls and floor systems.

6.4.4 Interior Conditioned Floor Area (iCFA)

The reference floor area. The space conditioning criteria (heating and cooling annual demands and peak loads) are per square foot of iCFA. See [Section 4.4.1.4](#) for the definition of iCFA.

6.4.5 Specific Heat Capacity/Thermal Mass

Regarding thermal mass, it is not just the total mass that matters but the distribution, so that it can interact with the infrared radiation bouncing around the room. The way of figuring this is based on the number of heavy surfaces (0 to six) per room, in an average sense. For example, a two-story building with a first-floor concrete slab would have 1/2 of a heavy surface per room on average.

Thermal mass is determined by the equation = $[60+n(\text{heavy})*24]*0.176$ (BTU/ft².F).

Guidelines for Accounting Heavy Surfaces

- Drywall = 0 heavy surfaces - (first ½" included in the baseline)
- 5/8" drywall = 0.34 heavy surfaces
- Double or high-density drywall = 0.5 heavy surfaces
- Two-inch-thick concrete or more, phase-change materials = 1 heavy surface
- Flagstone/tile = 0.5 heavy surfaces

- o **Example:**

Concrete floor = 1 heavy surface
Other 5 surfaces = 0.34 each = 1.7 heavy surfaces
Total n (heavy surfaces) = 2.7
Specific capacity = $(60+2.7*24) * 0.176 = 21.96 \text{ BTU/ft}^2\text{F}$

6.5 Visualized Components

6.5.1 Wall Components

Framing

Framing must be included. For walls, vertical and horizontal framing must be included. Typical assemblies are built out in 3D.

For wall assemblies with exterior continuous insulation, actual spacing of vertical framing should be used to define the 'width' of the typical assembly created, i.e. 16" o.c., and framing added in as horizontal subdivisions.

For wall assemblies with no exterior continuous insulation, framing factors of 25% should be used for 16" o.c. and 15% may be used for advanced framing (24" o.c.").

The 'height' of the assembly created should be defined by a typical floor to floor height. The top and bottom plates must be added into the assembly as vertical subdivisions.

Insulation Specifications

Some insulation is temperature-dependent; use the R-value at 75 F for the energy model. Some insulation is thickness-dependent; use the R-value at the appropriate thickness for the assembly.

In WUFI Passive, please note that default conductivity values are used from the existing database.

- Conductivity or thermal resistance values should be updated in the project file to match the insulation specification.
- This can be done under the Edit Assembly screen by clicking into the "Conductivity" input, for the specific assembly layer, selecting the [R/in] button, and inputting the accurate R per inch.

Surface / Radiation Balances / Solar Absorption/Emission

The radiation balances need to be input for every opaque surface above grade. This includes values for: emissivity, absorptivity, and shading. Rough values are acceptable.

6.5.2 Window Components

Phius has verified data for a number of windows and manufacturers; these are listed on the [Find & Compare Windows](#) page of the Phius website.

If the project is using windows included in the [Phius Verified Data for Window Performance Program](#), Phius' data must be used.

Window Components in 3D visualization: In the energy model, each individual 'lite' or individual 'piece of glazing' should be its own clickable component. This ensures that the proper solar gain and frame to glazing ratio is accounted for.

Window Groups in 3D visualization: In WUFI Passive, windows may be grouped/ungrouped and through the 'Assign Data' option given common properties.

- To add 'Basic Data' and 'Frame Data' and 'reveal' shading, they can be grouped by "Window Type".
- To add 'General Parameters' for site shading (fractions of solar exposure), you could group them by 'orientation' or by 'floor level'.
- WUFI Mean Monthly shading factors are calculated per window, regardless of grouping.

Window Sizes: The windows are entered into the building energy model in their actual size and configuration (every lite), with the performance of the framing members and the glass broken out separately (as opposed to using whole-window properties at a standard size.)

Window Performance Entries: Specification data is needed for:

- Center-of-glass (cog) U-value
- Solar Heat Gain Coefficient (SHGC) (cog)
- Frame width
- Frame U-value
- Linear heat loss coefficient at the edge of the glass ("psi-spacer")

Phius' window program calculates all these. But the project certification program is flexible as to the source of that data, that is, it is not "hostage" to the window rating program. Usually, center-of-glass properties can be obtained from the glazing system manufacturer. For the frame, rating data per CEN standards or NFRC's CMAST can be used, the [Phius Frame U-value Estimator](#) or a conservative default based on frame material type can be used. The linear coefficient at the edge is the hardest to come by, but a conservative default can be used for that (0.023 BTU/hr.ft.F). Similarly, a default value can be used for the linear heat loss coefficient at the outer edge of the frame ("psi-install").

Psi-Installation / Frame-to-wall psi-value

The frame-to-wall psi-installation value is dependent on how the window is installed within the wall. Please do not use values from manufacturers' data sheets unless they have completed a project specific calculation for you.

- A default value of 0.030 BTU/hr.ft.F can be used for most installation details.

- Improved detailed can use the values below:
 - As low as 0.020 (Btu/hr.ft.F) for a mid-wall mounted window that is not over-insulated.
 - As low as 0.015 (Btu/hr.ft.F) for a mid-wall mounted window that is over-insulated.
- If a THERM calculation is provided, psi-installation values below these thresholds are acceptable.

6.5.3 Solar Protection/Shading

6.5.3.1 Reveal Shading

Often windows are not installed flush with the exterior of the building façade which causes shading to the left and right sides of the window from the window in-set in the wall.

- Depth of window reveal: Measured from the outside of the leading shading edge to the glazing.
- Distance from edge of glazing to reveal: Measured from the edge of glazing to the shading edge.

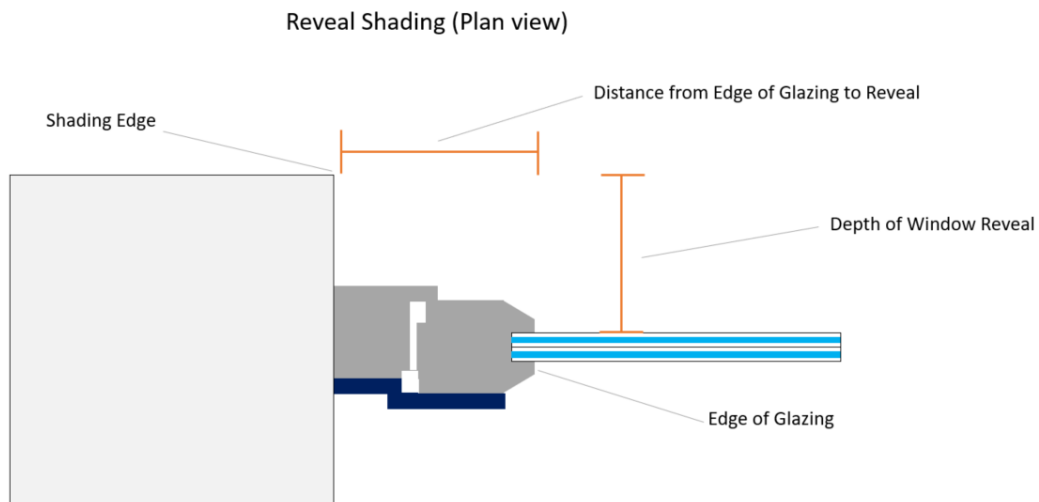

Reveal shading must be input for all windows.

- In WUFI Passive, this can be done quickly with the [Assign Data] function.
 - The 3D geometry will visualize the window in-set into the wall when entries are adjusted.
- All reveal entries are calculated as if on both sides of the window.
 - If the reveal depths are significantly different on the left and right, due to a vertical shading fin or similar, it is recommended that the irregular shading device is drawn into the 3D geometry rather than input numerically.
 - See 'Shading due to building geometry' below.

6.5.3.2 Shading Devices

Sunscreen/shading devices in WUFI Passive are assumed to be used only during the cooling season. If year-round blinds are used, please input as an “other shading fraction of solar exposure”.

External blinds offer better thermal protection than internal blinds because the solar radiation is partially absorbed by the fabric before reaching the glazing and reflected outwards.

The effectiveness of window blinds needs to be derated if they are manually operated, to account for occupant behavior. Phius has created the ‘Blinds’ calculator located on the [Resource Library](#) that follows the deration method noted in [Appendix N-8](#).

Blind Ratings: Should be provided by manufacturers. Solar transmittance is used in the equations above. Solar radiation is always partially transmitted through, absorbed, or reflected by the fabric.

Ts = Solar Transmittance – Proportion of solar energy transmitted through the fabric.

Low percentage means the fabric performs well at reducing solar energy.

Rs = Solar Reflectance – Proportion of solar radiation reflected by the fabric.

High percentage means the fabric performs well at reflecting solar energy.

As = Solar Absorptance – Proportion of solar radiation absorbed by the fabric.

Low percentage means the fabric absorbs little solar energy.

Ts + Rs + As = 100% of solar energy

OF = Openness Factor - Percentage of blind fabric/material that is open (between the threads)

Insulated Interior Blinds

Unless the blind is air sealed to the window opening and is airtight, much of the insulating value of the blind can be bypassed. Because of this, we are giving credit for essentially, the R-value of the two air films on either side of the blind and not the blind itself. We generally round this to R-2 in IP units. We also assume that user behavior impacts the use of the blinds and that somewhere around half the time, the blinds are not in the right spot, or are removed.

Therefore, we currently allow an R-1 adjustment to be made directly to the glass R-value and the Frame R-value. One word of caution is that if they do work as intended/advertised, there is a significant risk of condensation on the window in cold climates, which over time could lead to problems and durability issues. This must be checked and managed.

6.5.3.3 Overhangs

Overhangs may be included in the 3D geometry or entered numerically into WUFI Passive.

If included in 3D geometry, angled or complex overhangs may be modeled.

If entering numerically, an overhang parallel to the window head will be simulated. Three parameters must be defined:

- Depth of overhang: Measured horizontally out from the glazing to the shading

edge.

- Vertical distance from top of glazing to bottom of overhang: Measured vertically from edge of glazing to shading edge.
- Side spacing: The default side spacing is '0', which would simulate an overhang that matches the width of the window it is assigned to.
 - o If the overhang extends longer than the width of the window, 'side spacing' may be input to extend the overhang on each side of the window.
 - o At this time, the extension must be uniform on each side of the window.

The numerically entered overhangs will appear in the 3D geometry.

- If an overhang is both included in the 3D visualization and entered numerically, that is OK, it will not double count the shading if the two overlap in the 3D geometry.

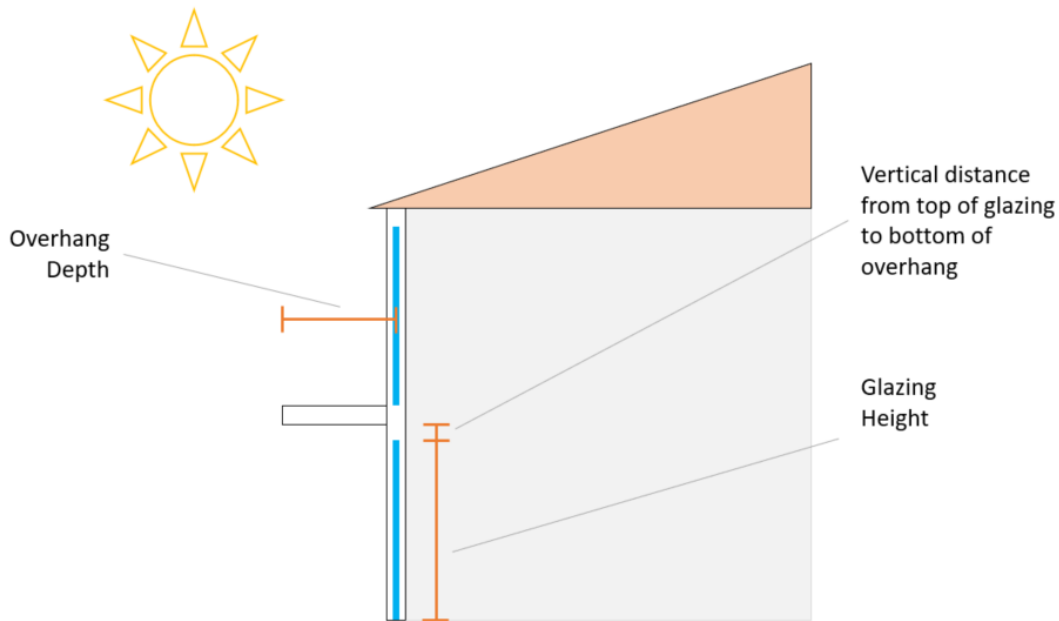

Please note in WUFI Passive, if no overhangs are assigned to a window, the reveal depth dimensions are automatically set as the overhang. If this inaccurately represents the shading condition, please assign an overhang to the specific window.

6.5.3.4 Mullied Windows and Divided Lites

Mulled Windows

If the connector for the frame mullion is similar in material to the frame, adding a bit of thickness to the frame may work. If the connector is substantially more conductive than the frame, a thermal bridge calculation may be necessary.

Divided Lites

There are some different ways to deal with true divided lites that bridge the gas cavity. The SHGC could be adjusted to account for the blocked light, and linear thermal bridges added to account for the extra conduction loss.

Simulated Divided Lites

If these are a kind of divided lites such that the gas cavity is not actually bridged, we will still reduce the SHGC, but no additional thermal bridging need be accounted for.

6.5.3.5 WUFI Mean Month Shading Factors

Shading due to building geometry

Shading from building geometry such as overhangs, bump-outs, complicated geometry, surrounding buildings etc. will be considered. For documentation to confirm site shading elements, refer to [Section 4.4.1.3](#).

- Any elements that should be considered for shading can be included in the 3D geometry imported into WUFI Passive. This includes overhangs, surrounding buildings, etc.
 - These elements should be assigned as 'opaque' and 'Outer Air' should be assigned on both the Inner Side and Outer Side of the components.
- The 'Calculate WUFI shading' button should be used.
 - If an entry changes that affects the shading calculation, a warning will appear stating "Shading factors are not up-to-date...". When this appears, the shading calculation must be re-run.
- Monthly shading factors are calculated and shown on the 'WUFI Mean Month Shading Factors' tab.
 - Correction/reduction factor per month can be applied in the row above the results, or
 - Default correction factor input can be used to apply a uniform reduction factor for all months.
- Results are calculated per window, even when windows are grouped.
 - Note: Unique shading properties such as reveals, numerically entered overhangs, blinds, etc. will not be retained per window if grouping and ungrouping. When windows are grouped, they are given uniform numerical entries based on the last window selected when grouping.
- More information can be found in [this presentation](#) from NAPHC2018.
- To account for deciduous trees or seasonal shading using 3D visualized geometry in WUFI Passive, refer to the [Site Shading Modeling in the New WUFI Passive Shading](#)

[Tool](#) webinar and [Contact Us](#) for access to the calculator and SketchUp plugin.

6.6 Internal Loads/Occupancy

6.6.1 Residential

Occupant Quantity: See [Section 6.3.1](#).

Number of Bedrooms: Based on the total number of bedrooms in the building.

Humidity Sources:

Internal sources due to respiration or evaporation. Default value of 0.00041 [lb/(ft²hr)].

Per ASHRAE standard 160, clause 4.3.2.1.1, if there is a jetted [whirlpool] tub installed in a room without an automatically controlled (e.g. humidistat) exhaust fan, it would be appropriate to add 1.3 liters/day or 0.12 lb/h to the moisture generation rate.

6.6.1.1 Calculation Methods

The energy use for most appliances is proportionate to the number of occupants. This holds true for dishwashers, clothes washers, dryers, and cooktops.

- o Generally, do not adjust the quantity of these appliances.
- o Default: If only 1 zone in the project, select “PH Case Occupants” as the “Reference Quantity”.
- o If multiple zones in the project, select “Zone Occupants” as the “Reference Quantity”.

For refrigerators and freezers, consumption is not dependent on occupancy, it is proportional to the number of devices.

- o Default: Select “PH Case Units” as the “Reference Quantity”.
- o The quantity may be adjusted as needed.

6.6.1.2 Devices/Appliances

Pre-defined devices are built into the software. Choose ‘Set Standard Dataset’ to insert one of each typical appliance. If a garage is present, this should be added by choosing ‘New’ and selecting ‘PHIUS+ Garage lighting’.

Below is a list of typical devices. Median Energy Star (ES) values as of 2021 are listed for each device. This may be used for projects early in design, or in some cases for design certification until the appliance is selected.

Dishwasher

| Water Connection | Reference Quantity | When Applicable? | Energy Demand ³⁴ (kWh/yr) | Capacity ³⁵ (place settings) |
|------------------|--------------------------|------------------|--------------------------------------|---|
| Cold | <i>PH case occupants</i> | Atypical | 269 | Standard (12) |
| DHW | | Typical | | |

Kitchen fridge/freeze combo

| Size (cu ft) | Reference Quantity | Energy Demand (norm) Reference | Energy Demand ²⁴ (kWh/yr) | Energy Demand ²⁴ (kWh/day) |
|--------------|--------------------------------------|--------------------------------|--------------------------------------|---------------------------------------|
| <10 | <i>PH case Units or User Defined</i> | <i>Day or Year</i> | 240 | 0.66 |
| 15-20 | | | 445 | 1.22 |
| >20 | | | 700 | 1.92 |

- For additional configurations review [Appendix N-2](#)

Kitchen freezer (stand-alone freezer)

| Reference Quantity | Energy Demand (norm) Reference | Energy Demand ³⁶ (kWh/yr) | Energy Demand ²⁶ (kWh/day) |
|--------------------------------------|--------------------------------|--------------------------------------|---------------------------------------|
| <i>PH case Units or User Defined</i> | <i>Day or Year</i> | 391 | 1.07 |

- For additional configurations review [Appendix N-2](#)

Laundry - washer

| Connection | Reference Quantity | When Applicable? | Energy Demand ²⁶ (kWh/yr) | Utilization Factor | Capacity ²⁶ (cu ft) | MEF ^{26,37} |
|------------|--------------------------|------------------|--------------------------------------|--------------------|--------------------------------|----------------------|
| Cold | <i>PH case occupants</i> | Atypical | 120 | 1 | 4.5 | 2.7 |
| DHW | | Typical | | | | |

- For additional configurations review [Appendix N-2](#)

³⁴ Median Value (ES, 2021). Calculated per [ANSI/RESNET/ICC 301-2014](#)

³⁵ Dishwasher Capacity: In place settings, from manufacturer or ES.

- Standard (12), Compact (8), or User Defined.

³⁶ Median Value (ES, 2021). Calculated per [ANSI/RESNET/ICC 301-2014](#)

³⁷ MEF (or IMEF) – (Integrated) Modified Energy Factor: From Energy Star. Consider the amount of dryer energy used to remove the remaining moisture content in washed items, in addition to the unit’s energy use and water heating energy. The higher the I/MEF, the more efficient the clothes washer.

- $MEF = 0.503 + 0.95 \cdot IMEF$

Calculated per [ANSI/RESNET/ICC 301-2014](#). Whereas, Annual Gas Cost (AGC) = Labeled Energy Rating*0.0593 + 3.7066

Clothes Dryer

| Type | Reference Quantity | When Applicable? | Energy Demand (kWh/yr) | CEF ³⁸ | Gas Consumption (Btu) |
|---------------|--------------------------|--|------------------------------------|--------------------|-------------------------------|
| Clothesline | <i>PH case occupants</i> | Only if there is no future hookup/space for the dryer. | Input any auxiliary or fan energy. | - | - |
| Drying Closet | | Cold | | - | - |
| | | Cold in-line with E/HRV exhaust | | - | - |
| Condensation | | Use for ventless or heat pump dryers | - | 5.79 | - |
| Exhaust Air | | Electric | - | 3.93 ³⁹ | - |
| | | Natural Gas ⁴⁰ | - | 3.49 ²⁹ | See Calculation ⁴¹ |

Kitchen Cooking

| Choice | Reference Quantity | When Applicable? | Energy Demand ⁴² (kWh/use) |
|-------------|--------------------------|------------------|---------------------------------------|
| Electricity | <i>PH case occupants</i> | Coil | 0.22 |
| | | Induction | 0.20 |
| Natural Gas | | - | 0.25 |

³⁸ CEF – Combined Energy Factor from Energy Star. Median CEF values as of 2021. Calculated per [ANSI/RESNET/ICC 301-2014](https://www.ansi-resnet-icc.com/ansi-resnet-icc-301-2014).

³⁹ Default CEF Value if no Energy Star rating: 3.14

⁴⁰ Select Field Utilization Factor – Timer controls or Moisture sensing

⁴¹ Match the electrical kWh/yr divided by 392 cycles per year of the washer and assign the rest to Gas consumption.

- For example, if using the default 11/ CEF = 3.5 kWh/use for the dryer, and the washer is rated at 196 kWh/yr / 392 cycles/yr = 0.5 kWh/use, input for the gas consumption:
- $3.5 - 0.5 = 3.0 \text{ kWh} * 3412 \text{ Btu/kWh} = 10236 \text{ Btu}$.

⁴² This input accounts for cooking energy from ovens, microwaves, etc., not just the cooktop. It is assumed that 500 single serving size meals are cooked annually, per occupant.

6.6.1.3 Lighting and Miscellaneous Loads

The list of devices covering lighting and plug loads are listed below. The annual energy use is calculated internally per [Section 6.6.1.1](#). Calculations referencing the iCFA should be calculated in square feet.

| Type | Reference Quantity | When Applicable? | Energy Demand (kWh/yr) | Fraction of high efficiency |
|---------------------------------------|---|--------------------------------------|-----------------------------------|--|
| Phius Interior Lighting | <i>PH case floor area</i> ⁴³ | Single Family Projects | - | If all LED / high efficiency, input 1. |
| Phius Exterior Lighting | | | - | |
| Phius Garage Lighting | <i>None</i> | Single Family Projects with a garage | - | |
| Phius MELS ^{44,45} | <i>Bedrooms</i> | Single Family Projects | - | - |
| User Defined - Lighting ⁴⁶ | <i>User defined (1)</i> | Multi-unit Projects (2+ units) | Varies ⁴⁷ | - |
| User Defined - MELS | <i>User defined (1)</i> | | Varies ³⁵ | - |
| User Defined | <i>User defined (1)</i> | For uncommon devices not listed. | Provide Calculation ₃₅ | - |

Multi-Unit Projects

- Energy use calculated for most appliances (dishwasher, washer, dryer, cooktop) are driven by occupancy. The “Reference quantity” that should be selected for these appliances is “PH case occupants” if the whole building is in one zone, or “Zone occupants” if the model has multiple zones.
- Fridge/freezer inputs are driven by the number of units input under the “PH Case” branch. The “Reference Quantity” in WUFI Passive for the fridge/freezer should be “PH Case Units”.

⁴³ If more than one zone is modeled, select ‘Zone Floor Area’.

⁴⁴ Includes all miscellaneous electric loads, including televisions and plug loads.

⁴⁵ If more than one zone is modeled, only add the Phius MELS device to one zone.

⁴⁶ Enter interior and exterior lighting as separate line items. For exterior lighting, uncheck the box for ‘In conditioned space’.

⁴⁷ Enter value from external lighting or MELS calculation for multi-unit projects (Download Phius Multifamily Calculator noted above and see [Appendix N-9](#)). This will separate lighting/MEL energy use in the WUFI reports. Do not enter commas – this will be interpreted as a decimal point.

- Calculating the lighting and plug loads should be done on a “per unit” basis using the Phius Multifamily Calculator.
- User Defined inputs are not applied to any internal patterns, and inputs are simply in kWh/yr. Therefore, when inputting lighting and plug loads as User Defined inputs, this should be for the whole building. (Or, if there are identical units, input per unit and adjust the quantity as needed).

Download the Phius Multifamily Calculator from the [Resource Library](#), which has all of the protocols noted in [Appendix N-9](#).

6.6.2 Non-Residential

Utilization Pattern

The internal loads and occupancy calculation for non-residential projects begins with the definition of utilization patterns. These patterns are used for two purposes: lighting energy calculation and internal gains due to people and the equipment they use.

A utilization pattern consists of a set of several parameters:

- Beginning hour
- Ending hour
- Days/year
- Illumination level
- Height of utilization (0 or 2.62 ft)
- Relative absence
 - o 1 = Occupants always absent
 - o 0 = Occupants never absent
- Part use factor of building period for lighting
 - o 1 = No reduction in lighting energy
 - o 0 = Full reduction in lighting energy

A set of standard default patterns (per DIN V 18599-10:2007-02, Table 4) is shown in the table in [Appendix N-10](#) below. [⁴⁸]

The illumination level, height of utilization, and part-use factor for lighting enter only into the lighting calculation.

The average occupancy (in ft²/person) can be entered. It factors into the total occupancy associated with a utilization pattern if the mode of planning for occupancy is floor-area-based rather than direct entry. It influences the calculation of gains from people and the equipment they use if any equipment is assigned to that Utilization Pattern.

The other parameters enter both the lighting and internal gains calculations.

⁴⁸ “DIN V 18599-10:2007-02.” *Energy Efficiency of Buildings — Calculation of the Energy Needs, Delivered Energy and Primary Energy for Heating, Cooling, Ventilation, Domestic Hot Water and Lighting — Part 10: Boundary Conditions of Use, Climatic Data*. Deutsches Institut für Normung (DIN), 2007. Table 4. Print.

Often, more utilization patterns will be needed for lighting purposes than for internal gains. For example, in an office building with single-shift operation and everyone typically sitting at desks, a single pattern could suffice for internal gains due to people, but if there are space types that require a few different illumination levels, more patterns would be needed for lighting. That is, it may be necessary / appropriate to define utilization patterns that “overlap” to support the calculations for internal gains, lighting, and equipment electricity use.

In the table in [Appendix N-10](#), the patterns are grouped by required illumination level. The first step in the analysis is to identify the different space types that are present, from the floorplan. In the lighting calculation, the patterns can be applied room-by-room. Grouping of rooms may be appropriate if they share a pattern (or ones with similar required illumination) and have similar access to daylight.

6.6.2.1 Occupancy

- **Occupant Quantity:** The top-level occupancy entry should reflect the average day occupancy. This value influences total DHW consumption, daily tap openings for DHW distribution losses, and the ‘Supply air due to persons’ ventilation requirement shown under Ventilation/Rooms>Utilization Pattern.
 - This entry does not influence the internal heat gains related to occupants.
- **Occupant Groups:** Occupant groups should be entered in the lines below.
 - Generally, each unique space type should have a new line entry.
 - Planned occupancy for the space should be entered.
 - Keep in mind that the relative absence on the ‘Utilization Pattern’ tab is relative to this occupancy.
 - Be careful not to double count occupants.
 - For example, if there is an office with 20 desks, that should be input with the 20 occupants. If there are also two conference rooms that serve the same occupants that occupy the desks, do not also add the conference room with 20 occupants, or that will double count the occupants. The conference room can be a separate line item for lighting, but not for occupancy.
 - Not all space types need designated occupants or entries on this tab.
 - Transient spaces such as stairwells, restrooms, storage spaces, etc. may have occupants at certain times, but those occupants should be included in the space types where they will reside the majority of the time they occupy the space.
- **Heat loss due to evaporation (per person):** Default value of 51.2 BTU/hr
- **Number of flush toilets:** Enter the total number of toilets in the entire building.
- **Toilet Utilization Pattern:** The utilization pattern with the most ‘Annual utilization days’ should be selected.

6.6.2.2 Office Equipment

Planned equipment for the building should be input here.

- Pre-defined equipment types are built in.
- Power Rating [W] must be input for all equipment.

See [Appendix D – ASHRAE Fundamentals Non-Residential Equipment Tables](#) below for guidance on office equipment power ratings.

PC, Monitor:

- o A utilization pattern must be assigned to each of these equipment types.
- o The amount of time in operational mode vs power saving mode is built in.

Copier, Printer:

- o A utilization pattern must be assigned to each of these equipment types.
- o The number of hours in energy savings mode will be calculated automatically. Or you may define this number. The number of hours input here is out of the total hours in the Utilization Pattern – not out of all 8760 hours in a year.

Telephone system:

- o The quantity should be input, and the energy use is not dependent on the number of occupants.

User Defined:

- o Enter the Power Rating [W] and the Utilization Hours per year.
- o May be used for any miscellaneous items that do not fit the built-in options.
- o External calculation for equipment energy use may be completed to determine kWh/yr. To input these external results:
 - Enter the resulting kWh/yr as the Power Rating [W]
 - Enter 1000 hrs/yr for the utilization
 - The result will be [W] * 1 khr/yr = kWh/yr.

6.6.2.3 Kitchen Equipment

Planned kitchen equipment for the non-residential building should be input here.

- Pre-defined equipment types are built in.

Cooktop:

- o Utilization patterns must be defined to define the utilization days per year.
- o Number of meals per utilization day refers to the total number of meals cooked in that zone, per day.
 - By default, the model will assume 0.25 kWh/meal for cooking energy.
- o Quantity can also be input. Be sure not to double count the meals by adjusting the quantity. If quantity is adjusted, meals per individual cooktop should be input.

Dishwasher

- o Utilization patterns must be defined to define the utilization days per year.
- o Number of meals per utilization day refers to the total number of meals cooked (place settings washed) in that zone, per day.
 - By default, the model will assume 0.055 kWh/meal for dishwashing energy.

Refrigerator

- o Norm demand [kWh/day] must be input.
- o This data is available from Energy Star for residential fridges and some commercial fridges.
- o To estimate energy use for walk-in fridges/freezers, an external calculator is available for download [here](#).

User Defined

- o May be used for any miscellaneous items that do not fit the built-in options.
- o External calculation for equipment energy use may be completed to determine kWh/yr. To input these external results:
 - Enter the kWh/yr calculated into the 'kWh/day' field
 - Enter 1 day/yr
 - The result will be kWh/day * 1 day/yr = kWh/yr

6.6.2.4 Lighting

Space types should be split out into individual line items here.

If multiple Utilization Patterns are used to define the full usage hours for a single space, that space must be entered multiple times on this sheet and assigned to the appropriate Utilization Patterns to cover all hours of usage.

Fraction of conditioned floor area:

- o This should generally add up to 1 for any given Utilization Pattern.

Daylighting: WUFI Passive will estimate daylighting potential by requiring the following inputs:

- **Derivation from North:** 0=North, 180=South
- **Glazing Visible Transmittance:** Select a predefined option, or enter User Defined if known. This value is generally provided by window manufacturers.
- **Room Depth:** Enter the room depth starting from a window on the wall defined in the Derivation from North.
 - o For example, if you input 180, select a 'typical' window on the south wall and measure to the north wall enclosing that space.
- **Room Width:** Measure in the opposite direction of the Room Depth described above.

- **Room Height:** Floor to ceiling height.
- **Façade has windows:** Check this box if applicable. If not applicable, do not check the box and no daylighting potential will be assumed.
- **Lintel height:** Height of the typical window head from the floor.
- **Window width:** Sum of all the window widths on the wall specified above for 'Derivation from North'.

Installed Lighting Power: Value should be input in W/ft^2 . Phius requires lighting plans and documentation to verify these values.

- Values entered here will override 'illuminance [lux]' entries from the Utilization Pattern.

Lighting full load hours: This entry will override all entries utilized for the daylighting calculation built into the software.

- The daylighting calculation utilizes the Derivation from North, Glazing Visible Transmittance, Room Width/Depth/Height, Façade with windows checkbox, lintel height, and window width.

6.6.2.5 Process Loads

As mentioned in [Section 3.1.4.1](#), process load allowances may be defined for commercial projects. Each unique process load should be input as an individual line item.

- Total energy in kWh/use may be input, or
- Power Rating [W] and Annual use hours [hr] may be used with the built in [...] calculator

Include in Source Energy Total: This checkbox allows the modeler to include/remove this process load in the calculated source energy total for the purposes of verifying compliance with the base source energy target before process loads and allowances are included.

Increase Source Energy Allowance: This checkbox allows the modeler to adjust the source energy target by including the process load allowance in the model. This will auto-adjust the Source Energy target in the results to include this allowance

- Note: Process load allowances must be reviewed and approved by Phius.

6.7 Ventilation/Rooms

6.7.1 Utilization Pattern

The design airflow is determined by the largest of 2 factors:

1. Supply air requirement (based on occupancy)
2. Exhaust air requirement (based on kitchens, baths, etc.)

The capacity of the ventilation system installed needs to exceed whichever rate is greatest⁴⁹ (see [Section 3.5](#)).

The average air flow rate (cfm) and average air change rate (1/hr) is calculated as a reduction from the “design air flow rate”. It is determined by the daily operation schedule and “fraction of design” airflow at the scheduled hours.

For non-residential projects, multiple utilization patterns may be set up to reflect varying levels of ventilation rates for different days (i.e. weekday vs weekend). Alternatively, one utilization pattern may be used and the ‘daily operation schedule’ can be revised to reflect the appropriate ratios of design airflow rates during occupied and unoccupied hours.

6.7.2 Rooms Ventilation

In WUFI Passive, it is best practice to enter both exhaust rooms and supply rooms, though only exhaust room entries are required if the model is set up with ‘Balanced Ventilation’ (under PH Case>Additional Data).

- Entering all rooms ensures the ventilation design is balanced.
- “Supply rooms” *must* be entered if there is to be more than one H/ERV device entered.
- When adding exhaust rooms, input 0 cfm supply. When adding supply rooms, input 0 cfm exhaust.

For multi-unit buildings with repeated exhaust rooms, the room may be input once, and the quantity adjusted appropriately. For example, a 50-unit MF building with 50 kitchens may have a single line entry for the kitchen, quantity 50, if the exhaust flow rate is planned to be the same for all kitchens.

Phius recommends starting with the following exhaust rates as rules of thumb for single family projects. Multifamily projects may have lower rates, but should not fall below the minimum ventilation rates outlined in [3.5.2.3](#):

Kitchen: 35 cfm

Bathroom: 24 cfm

Half Bath: 12 cfm

⁴⁹ For design certification, it is recommended (but not required) that residential projects model with a ventilation rate of 0.3 ACH or higher.

6.7.3 Summer Ventilation

Summer ventilation may be notionally either natural, via windows, or mechanical automatically controlled (e.g. whole house exhaust fan.)

Summer Mechanical Ventilation by the HRV/ERV

Average mechanical ventilation air change rate [1/hr]:

By default, this value should be left empty if the E/HRV runs year-round. This value should match the year-round average ACH from the E/HRV.

If the climate allows for summer ventilation to be taken care of through windows and other passive features, and the HRV/ERV will be shut off, input 0 here.

**Note: Occupants must provide other means of ventilation if turning off the continuous ventilation system.*

Summer Bypass

Summer/HRV Humidity Recovery:

Some heat recovery ventilation units (both ERVs and HRVs) can bypass heat recovery in the summer when outdoor temperatures are more favorable than indoor. Also referred to as 'economizer mode' or 'free cooling'. Typically, this is a temperature-controlled bypass.

- None: If there is no heat/moisture recovery ventilation during the summer. (Only applicable if the E/HRV is shut off during the summer)
- Temperature-controlled bypass: If the bypass mode is activated based on temperature.
- Enthalpy-controlled bypass: If the bypass mode is activated based on both temperature and humidity/moisture.
- Always: If there is no bypass mode and recovery mode is always active.

Summer Natural Ventilation (day)

ACH via natural ventilation (day):

If a cooling system is planned, no natural ventilation may be included in the model. An entry of '0' is required for Phius 2021 certification.

- If no cooling is planned, up to 0.3 ACH may be used.

Additional Summer Ventilation (night)

ACH via natural ventilation (night):

If a cooling system is planned, no natural ventilation may be included in the model. An entry of '0' is required for Phius 2021 certification.

- o If no cooling system is planned:
 - Be cautious and realistic with the amount of natural ventilation being counted on for cooling. There are two main concerns with the amount of cooling.
 1. Humidity - look for dew point temperature in the Climate Data. In many climates in the United States, there are high levels of humidity in the cooling situations.
 2. The built-in summer ventilation calculator can generate quite high air change rates, but during the night usually interior doors are closed so that cross ventilation is cut off.
 - For Phius Certification, either:
 1. Account for no higher than 0.3 ACH for nighttime ventilation; or
 2. Follow Building America House Simulation Protocol, which states: 33% of the open-able windows are opened. This can happen 3 days a week (M, W, F), which would translate to a fraction of opening duration of 43%, Or 10.3 hrs/day.

Use the additional calculator found under Summer Ventilation in WUFI Passive Model each window in one column. A second window group is allowed for stack effect and cross ventilation only for day, not night (unless there are no intervening doors.)

Additional Summer Mechanical Ventilation

Use these inputs when implementing a mechanical exhaust system in addition to the ERV. Ex: whole house fan. Use [Mechanical automatic controlled ventilation] if the system is tied to sensors for either temperature or humidity difference and define the control system in WUFI Passive.

- o ACH via mechanical ventilation exhaust air.
- o Mechanical automatic controlled ventilation
 - a. Specific Power Consumption

6.7.4 Exhaust Ventilation

Exhaust Air Appliances:

In WUFI Passive, account for the exhaust appliances on the Ventilation/Rooms > Exhaust Appliances tab. Direct exhaust devices should be reviewed to confirm if a make-up air system will be required per section [3.5.2.1](#).

Exhaust Dryers and Exhaust Range Hoods

- There are pre-defined devices for exhaust dryers and exhaust range hoods over kitchen cooktops, which are tied to the annual usage patterns of the dryer and cooktop.
- Only input a single exhaust device per type and enter the average airflow per device type.
 - **Example:** A multifamily building has a common area laundry room with 5 direct exhaust dryers that each run independently of each other at 220 cfm. Input a single line item in the software, assign the 'Type' to 'Exhaust Dryer' and input 220 cfm as the 'Exhaust volume flow rate'.

Bathrooms with direct exhaust fans: There are two acceptable methods to account for this:

- Assume 60 min/bathroom/day per BAHSP protocol
 - Exhaust volume flow rate [cfm]: Sum total bathroom exhaust fans in the building and enter that here.
 - Run time per year [min]: Use $(365 \text{ days/yr} * 60 \text{ min/day}) = 21,900 \text{ minutes/yr}$
- Alternate: Assume 30 min/person/day
 - Exhaust volume flow rate [cfm]: Average exhaust flow rate of all bathroom exhaust fans in the building. Enter that exhaust rate for the *average* bathroom here.
 - Run time per year [min]: $(30 \text{ min/occ/day} * \text{Occupants} * 365 \text{ days/yr}) = \text{minutes/yr}$

Unbalanced Airflow: If at final commissioning, the exhaust or supply air flow of an individual ventilator exceeds the exhaust air flow by more than 10%, the energy penalty must be accounted for. This can be done by modeling the associated additional infiltration or exfiltration, assuming that this unconditioned airflow will be continuous at the same rate as the difference between the supply and exhaust air flows. See alternate method in [Section 6.10.8 Mechanical Ventilation Devices](#).

Multiple Exhaust Dryer Protocol:

If a community building (or similar) is serving multiple residential buildings, the multiple dryer exhaust protocol may be applicable. When these buildings contain a laundry room with exhaust dryers, and the usage pattern is high, this increases the load on the space conditioning system (and increases the modeled annual demands and peak loads).

In these cases, the increase in space conditioning energy use due directly to the makeup air required for the dryers must be accounted for in the source energy calculation. However, it does not need to be accounted for in the same way as typical exhaust dryers, which would

influence the modeled annual demands and peak loads of that building. Instead, see modeling protocol below to account for this additional energy.

- Duplicate the existing case, create a new 'test' case.
- Add the dryers to the Exhaust Appliances tab in WUFI Passive .
- Take the *difference* between the added heat demand and the added cooling demand. (On the theory that cold air makes the dryer work harder, warm air makes it work easier, than it does under its rated conditions.)
- Convert that to a source energy using the COP and SE factor of the dryer. Divide by the source energy factor for electricity and enter the result as an auxiliary electric load outside the thermal envelope.
- Furthermore, it is recommended to install an electric heater in the makeup air duct (near the point of entry) capable of raising the air temperature to at least 49 F (dew point of 68 F air at 50% RH.)
- If the dryer is not electric resistance, the SE factor in the above energy calculation should be adjusted with a seasonal weighting based on the percentage of the year that the makeup air heater would be expected to operate. This would prevent the makeup air from causing a frost or condensation problem.

Notice that, if the space heating system is efficient or has a low source energy factor, a heated makeup air duct may use more energy overall in a site or source energy sense. Therefore, this is not necessarily the best strategy in all cases. The multiple exhaust dryer protocol is offered as an option that may help some smaller buildings meet the certification criteria for space conditioning. This protocol does not apply to centralized laundry rooms in multifamily buildings.

6.8 Thermal Bridges

To learn how to use THERM software developed by Lawrence Berkeley National Laboratory (LBNL) to calculate thermal bridges, an introductory training course may be purchased from the [Intro to THERM Workshop](#) page on the Phius website.

Phius has created a [Psi-Value Calculator Template](#) for consultants to use to document and calculate a project's thermal bridges.

Negative Thermal Bridges: If accounting for any negative thermal bridges, all thermal bridges in the project must be calculated, no matter how small. In general, Phius strongly recommends against taking negative thermal bridges in the design phase, and only using these as a "last line of defense".

Temperature Zone Assignments in WUFI Passive

| WUFI Passive Attachment | Temperature conditions in psi-value calculation | | |
|-------------------------|---|----------------|--------------|
| | Interior (68F) | Exterior (14F) | Ground (41F) |
| Ambient | x | x | |
| Perimeter | x | x | x |
| Basement Floor | x | | x |

- **Ambient:** Use this selection for thermal bridges occurring above grade. Only two temperatures will be used in the THERM/psi value calculation – interior and exterior.
- **Perimeter:** Use this selection for thermal bridges occurring at grade. In this case, there will be three temperature zones used in the THERM calculation – interior, exterior, and ground.
- **Ground Floor:** Use this selection for thermal bridges below grade. Only two temperatures will be used in the THERM calculation – interior and ground.

6.9 Attached Zones & Remaining Elements

6.9.1 Attached Zones

Reduction Factors for Tempered Spaces

In passive house verification mode, the lowest reduction factor currently allowed for Phius Certification is ≥ 0.95 . One example of this is a garage. Garages may be warmer in the winter and afford a reduction to the assemblies that come into contact with it. However, it also could be warmer in the summer. The exact reduction factor cannot be calculated in passive house verification mode and a conservative approach is being taken.

If there is an infill project built directly adjacent to existing buildings, the walls neighboring the existing building can be assumed adiabatic if the space is occupied and residential or if the space is non-residential and always conditioned. The neighboring walls should be set to 'Space with the same inner conditions'. (This will result in a slightly higher heating load than setting up the neighboring building as an 'Attached Zone w/a temperature reduction factor of 0'). Review the Guidelines for using SketchUp with WUFI Passive pdf from the [Resource Library](#).

6.9.2 Remaining Elements

Any components with 'Outer Air' or 'Ground' assigned to both the 'Inner side' and 'Outer side' will appear as remaining elements. This may include shading elements that are outside of the thermal boundary, a roof over a vented attic, etc.

The remaining elements only influence the calculation via the dynamic shading calculation. No heat transfer is considered through these components.

6.10 Systems

In WUFI Passive, systems consist of a set of devices. Often, only one 'System' is needed per building. There are cases where multiple systems must be used, such as to add system capacity, or due to a limitation in the WUFI Passive software. More details below.

Devices must be added to cover Space Heating, Space Cooling (if applicable), Mechanical Ventilation and Domestic Hot Water (DHW).

System Coverage: If more than one 'device' serves the same purpose, all devices should be added, and the appropriate coverage should be assigned for each. Coverage can be determined based on the capacity of each piece of equipment used (i.e. if multiple different heat pumps are used with different performance ratings), or priority (i.e. heat pump for heating with backup electric resistance heaters). Coverage is assigned below the device list.

6.10.1 Hydronic Heating Distribution

Hydronic heating

If there are hydronic pipes used for heating in the project, they should be accounted for under this tab. These inputs account for the distribution losses of the hydronic piping to the surrounding space, or if the pipes leave the building envelope, the losses to the ambient conditions.

Design Flow Temperature: This input should be the temperature of the water in the piping. This can be determined by the mechanical sequence of operations, or leaving water temperature on the mechanical schedules for the heating plant equipment.

Length of Distribution Pipes: This input describes the lengths of pipes in the project. This should be calculated by a takeoff on the drawing set between the heating plant and the terminal devices, for example between the boiler and the fan coil unit, or between the boiler and the manifold for the radiant slab. Only include the length of hot water supply pipes, do not include hot water return piping.

Heat Loss Coefficient per ft Pipe: This input characterizes the heat loss from the piping per linear length. Click into this input cell and use the built-in [...] calculator and input details about the pipe size and insulation.

Temperature of the Room the Pipes Pass Through: Input the average annual temperature for piping outside of the conditioned space (the visualized geometry in WUFI). This can include mechanical tunnels, or ambient conditions.

Design System Heating Load: If different from the heating load calculated by WUFI, enter a design (peak) heating load for this system. Otherwise, leave blank.

Flow Temperature Controlled: If the flow temperature in the hydronic distribution is constant throughout the year, leave this box unchecked. If the flow varies throughout the year, for example if the water temperature changes in the cooling season, check this box.

6.10.2 Domestic Hot Water (DHW) Distribution

DHW

Make sure the reviewer can verify the hot water distribution technology from the mechanical drawings. Document the actual pipe lengths used for the applicable entries described below.

Design Flow Temperature: This is used to calculate the circulation pipe losses. Phius will accept between 120-140°F. It is recommended, and common, to insulate plumbing. This is mostly to improve efficiency and slow the heat transfer from the pipe to the interior environment. Although this is recommended, it is not required.

6.10.2.1 Circulation Pipes

- **Length of Circulation Pipes**: A true circulation loop has hot water running through it for a certain period each day. Referred to below as ‘Continuous or time-based recirculation’. The full length of these pipes should be entered here.
 - Continuous or time-based recirculation systems are only allowed in multifamily projects with more than 6 stories or in non-residential buildings.
 - **Neither time-based nor continuous recirculation systems are allowed in single family homes nor multifamily projects of five stories or less.**
 - For this entry, determine the length of the circulation loop. The default calculation for the recirc pumping energy auto-sizes a pump based on the gross enclosed volume of the building, and conservatively assumes 24 hour a day operation. This can be overridden.
- **On-Demand Recirculation**: When recirculation is triggered by a demand-based system (See [N-11.1](#)), rather than continuous/time-based, do NOT enter this as circulation pipes.
 - Use the ‘Individual pipes’ entry, select ‘Hot water piping calculator’. See [PATH B](#) below.
 - The cautious view is that an on-demand system saves water, but it does not save much water heating energy, because the pipes cool off between uses like the individual branch pipes.
- **Daily running hours of the circulation**: 24 hours for continuous, or lower for time-based.

- o Phius strongly discourages, but shall not prevent, the use of continuous or time-based hot water circulation systems in multifamily buildings of 6 or more stories and in non-residential projects.

6.10.2.2 Individual Pipes – Calculation Methods

1. Simplified Individual Pipes

This method should be used for all non-residential projects.

- o **Length of individual pipes:**

- To determine this, determine the distance from the DHW source to each individual hot water tap. Sum these distances to find the total length of individual pipes.
- For hot water pipes to the clothes washer and dishwasher, exclude the length of these pipes, or more conservatively, apply a reduction factor of 0.06 to the length.
- If the project is using a continuous or time-based circulation loop, determine the distance from the recirc loop to each individual hot water tap. Sum these distances to find the total length of individual pipes. (Note that a supporting drawing / diagram is part of the required documentation.)

- o **Exterior Pipe Diameter:** Typically add 1/8" inch to the nominal pipe dimension to determine the exterior dimension. Projects using a variety of HW pipe thicknesses may use a weighted average for this value.

2. Simplified hot water piping calculator

- o May be used early in design. Not accepted for design nor final certification.
- o **Pipe material:** Select the pipe material used. More information can be found in [Appendix N-1](#).
- o **Pipe diameter:** Nominal pipe diameter in inches.
- o **Number of bathrooms:** Sum of all bathrooms in a building covered by the DHW device in this 'System'.
 - If multiple 'Systems' with DHW devices are defined in WUFI Passive, do not double count bathrooms.

3. Hot water piping calculator (unit method)

- o This calculation method is required for all residential PHIUS+ 2018 & Phius 2021 projects.
- o This calculator estimates hot water distribution losses, as well as 'time to hot' used to aid in the design of a DHW distribution network that will meet the [EPA WaterSense Hot Water Delivery requirements](#).

- o The length of Demand-based recirculation pipes SHOULD be entered here. The length of time-based or continuous hot water recirculation pipes SHOULD NOT be entered in this section, but rather above under Circulation Pipes.
 - o *Hint:* When considering how to enter the DHW distribution network, consider the source of the 'hot' water, as well as the full path from the source of the hot water to each individual tap.
- o For the purposes of this calculation, hot water lines to dishwashers and clothes washers can be ignored.
- o Sample DHW Distribution takeoff and WUFI Passive entry screen inputs can be found in the [Resource Library](#).

6.10.2.3 Individual Pipes – Steps for 'Hot Water Piping Calculator'

Step 1: Fill out the upper portion of the Hot water piping tab.

- o Preselection effectiveness: Determined by the type of hot water fixtures used in the project. If 'Low-Flow' fixtures are used as defined by the [EPA WaterSense](#), choose 'Low flow'. This should be verifiable with a fixture schedule.
- o All pipes insulated: Check this box if all hot water piping will be insulated. This should be verifiable from a note in the plans.
- o Count of units or floors:
 - PH case setting is the default and can be used for projects with a single unit configuration for water distribution (ie. single family homes with a single water heater and multifamily projects with identical dwelling units with individual water heaters).
 - For all other cases, this entry should be set to 'User Defined' so that the actual quantity of unique units can be input in Step 3 noted below.

Step 2: Identify the water distribution configuration and follow the Path from the chart below.

| Recirculation Type | Path |
|--------------------------|-------------------|
| None | A |
| On-Demand | B |
| Continuous or Time-Based | C |

----- Follow the path below -----

PATH A: No Recirculation

Step 3A: For DHW distribution systems where no recirculation is provided.

Summarize DHW trunks □ create A list of each unique unit types. A unit type is designated as 'unique' if it has a unique DHW layout.

- o Name: Name trunk based on Unit Type (i.e. A, B, C, etc).
 - For single unit buildings, only one trunk should be included from the water heater to where the first branch diverges.
- o Demand recirculation: Leave unchecked if no on-demand recirculation is planned.
- o Length: The trunk always starts at the water heater and should end where the first branch diverges from it. Takeoffs should be provided to verify this input.
- o Count of units or floors: Number of times this unique unit occurs. Override this input as needed as noted in Step 1.
- o Pipe material, diameter, heat capacity, volume [oz] and cumulative volume [oz]: Review definitions in [N-11.2](#).

Step 4A: Summarize DHW twigs □ create a list of hot water fixtures in each unique unit type.

The twig is the small diameter piping that serves an individual fixture.

- o Name: Name based on DHW tap in the unique units listed above, with a 'T' at the front or end.
- o Length: A twig only serves one fixture. To determine twig length, work from the fixture back to a central pipe that serves more than one fixture (branch).
 - Enter the entire twig length from the adjoining branch for each fixture no matter how many turns/twists.

Step 5A: Summarize DHW branches □ create list of branches connecting trunk to twig. Each twig will have its own branch, running from the trunk to the twig.

- o Name: Name based on DHW tap in the unique units listed above (same as twig but without 'T')
- o Length: Total length between twigs and trunks above.
- o If a twig connects directly to a trunk, enter a branch with a length of '0' and connect the twig to that branch.
- o Sometimes a branch off the trunk may only serve one fixture. In that case, it could all be considered a twig, or could be split into a branch and a twig. If the pipe dimension and material are the same, either method will yield the same results.

Step 6a: Enter information from spreadsheet above into WUFI Passive.

- o A segment must be entered first with the trunk, then connecting branch, then connecting twig.
- o To 'connect' a branch to a trunk, you must first click on the trunk, then add that branch.
- o To 'connect' a twig to a branch, you must first click on the branch, then add that twig.
- o Be careful to ensure you are always connecting the appropriate segments.

Step 7A: Use the 'Watersense met?' column built into the twig entries to estimate whether all fixtures will pass the EPA WaterSense Hot Water Delivery requirement.

- o This is an on-site test that applies to all residential projects with individual water heaters.

- o Exception: No requirement for centralized DHW systems in multifamily projects.
- o This tool is used to aid in the design of a DHW distribution network that will pass on-site testing, but does not guarantee it.
- o If a twig is not passing in the model, it is recommended to revise the tap location or circulation strategy for that tap.

Step 8A: Double check entries:

- o All trunks must have branch entries
- o All branches must have twigs connected.
- o Quantities must appropriately represent the building distribution network.

PATH B: On-Demand Recirculation

Step 3B: For systems employing a demand recirculation strategy that is verifiable from the plumbing plans and includes a sequence of operations that designates the demand controls provided.

DHW trunks □ Designate a trunk or trunks to account for the on-demand recirculation loop.

- o Demand Recirculation: Check this box and review [Appendix N-11.2](#) for description.
 - Note: On-demand trunk entries in multi-unit buildings are the only type of trunk that does not require a branch to be attached to it.
- o For multiple unit buildings, additional trunks that are not part of the on-demand recirculation loop need to be included in separate trunk lines to account for unique dwelling unit configurations.
- o Name: Varies by trunk type.
 - On-Demand Trunks
 - Name 'On-Demand'
 - Trunks to individual units off of circulation loop
 - Name based on unit number (i.e. 401, 402, 403).
- o Length: Varies by trunk type.
 - On-Demand Trunks
 - Enter the total length of the Supply side of the loop, omit Return portion (downstream of last fixture and recirc pump temperature sensor.)
- o Count of units or floors: Number of times this unique trunk condition occurs. Override this input as needed as noted in Step 1.
 - On-Demand Trunks
 - Multiple demand recirculation trunks are only required if the pipe diameter varies along the on-demand loop.
 - Trunks to individual units off of circulation loop
 - Should match the quantity of each unique unit configuration.

Step 4B: Summarize DHW twigs □ create a list of hot water fixtures in each unique unit type.

The twig is the small diameter piping that serves an individual fixture.

- o Name: Name based on DHW tap in the unique units listed above, with a 'T' at the end.
- o Length: A twig only serves one fixture. To determine twig length, work from the fixture back to a central pipe that serves more than one fixture (branch).
 - Enter the entire twig length from the adjoining branch for each fixture no matter how many turns/twists.

Step 5B: Summarize DHW branches □ create list of branches connecting trunk to twig. Each twig will have its own branch, running from the trunk to the twig.

- o Name: Name based on DHW tap in the unique units listed above (same as twig but without 'T')
- o Length: Total length between twig and trunk above.
 - If a twig connects directly to a trunk, enter a branch with a length of '0' and connect the twig to that branch.
 - Sometimes a branch off the trunk may only serve one fixture. In that case, it could all be considered a twig, or could be split into a branch and a twig. If the pipe dimension and material are the same, either method will yield the same results.

Step 6B: Enter information from spreadsheet above into WUFI Passive.

- o A segment must be entered first with the trunk, then connecting branch, then connecting twig.
- o To 'connect' a branch to a trunk, you must first click on the trunk, then add that branch.
- o To 'connect' a twig to a branch, you must first click on the branch, then add that twig.
- o Be careful to ensure you are always connecting the appropriate segments.
- o Note that pipe material, diameter, and length must be added for each new segment.

Step 7B: Use the 'Watersense met?' column built into the twig entries to estimate whether all fixtures will pass the EPA WaterSense Hot Water Delivery requirement.

- o This is an on-site test that applies to most residential projects.
 - o Exception: No requirement for centralized DHW systems in multifamily projects.
- o This tool is used to aid in the design of a DHW distribution network that will pass on-site testing, but does not guarantee it.
- o If a twig is not passing in the model, it is recommended to revise the tap location or circulation strategy for that tap.

Step 8B: Double check entries:

- o All trunks must have branch entries
 - o Exception: On-Demand trunks in multiple units buildings should not have a branch and twig.
- o All branches must have twigs connected.
- o Quantities must appropriately represent the building distribution network.

PATH C: Time-based or Continuous Recirculation

Step 3C: For systems employing a continuous or time-based recirculation strategy that is verifiable from the plumbing plans and includes a sequence of operations that designates the controls provided.

Distribution □ DHW □ General □ Follow the instructions from [Section 6.10.2.1](#)

- o This type of recirculation system is only allowed in multifamily buildings of 6 stories or more with centralized DHW systems and non-residential projects.

Step 4C: Follow the same steps as [PATH A](#).

6.10.2.4 Distribution Pipe Materials and Sizes

See [Appendix N-1](#) for a table on DHW distribution pipe materials and sizes.

6.10.3 Cooling

Cooling system properties are entered under System>Distribution>Cooling, rather than in individual cooling devices. If you are specifying varying cooling systems, add a new 'System', and a new device for cooling in that new system. It is not currently possible to enter varying cooling performance specifications when two cooling devices are included in the same 'System'.

- **Coverage:** WUFI Passive will estimate the available cooling coverage based on system entries. If the cooling demand is not covered, this will appear as a warning under the 'Data state/results' box. If the cooling demand is not covered, capacity must be increased either by changing the numerical entries or adding an additional cooling system.
- **Cooling via ventilation air:**
 - o Use this for cooling systems that cool incoming fresh air/outdoor air supply, in-line with the ventilation, and are not using additional airflow to satisfy the cooling needs.
 - o Supply air cooling capacity: From manufacturer, based on available ventilation airflow and cooling coil.
 - o Supply air cooling COP: Use EER/3.412
- **Recirculation Cooling:**
 - o Use for heat pump systems that cool indoor, recirculated air.
 - a. Recirculation air flow rate: Rated values provided by manufacturer, or estimate between 250-400 cfm/ton of cooling
 - b. Recirculation air cooling capacity: Rated value from manufacturer.
 - c. Recirculation Cooling COP: Use $((SEER + EER)/2) / 3.412$.
 - i. If only EER is provided, $SEER = (1.12 - \sqrt{1.2544 - 0.08 * EER}) / 0.04$
 - ii. For commercial cooling units, the cooling COP may be estimated using the

IEER rating. Use (IEER/3.412 = COP)

iii. $IEER = (0.02 * A) + (0.617 * B) + (0.238 * C) + (0.125 * D)$

Whereas:

A = EER at 100% net capacity at AHRI standard cond. (95 deg F)

B = EER at 75% net capacity and reduced ambient (81 .5 deg F)

C = EER at 50% net capacity and reduced ambient (68 deg F)

D = EER at 25% net capacity and reduced ambient (65 deg F)

- **Dehumidification COP** use dehumidifier rating in Liter/kWh
 - 1 Liter/kWh = 0.625 COP
 - OR, use a COP of '1.2' for cooling systems that provide latent cooling as a product of sensible cooling. (air source heat pump, mini-split, VRF etc..)
- **Panel Cooling**
 - Only used for radiant cooling systems. External calculation needed to determine Panel Cooling COP.

6.10.4 Ventilation Distribution

Duct Length and Duct Separation

Supply and exhaust duct lengths should be measured from the inside of the exterior wall to the outside of the ventilation unit. Often, these lengths are different.

If there are multiple H/ERVs in the project covered by a single ERV device, do not increase the quantity of duct lengths input here. For example, if there are 50 identical ERVs in the project, the ERV device will have a quantity of 50. Determine the average supply/exhaust duct length for those 50 ERVs, and input only one entry for a supply duct, and one for exhaust. Then, check the box to assign those two average-length ducts to the appropriate ERV type. This will accurately assign those ducts to the 50 ERVs.

On the outside of the building the supply and exhaust diffusers should be located at least 10 feet apart to keep from short circuiting exhaust air back into the house.

Note: If the ventilation unit is running at a very low airflow, manufacturers may allow for less separation. This will be reviewed on a case-by-case basis.

Taking the supply air from above the roof is generally not recommended, because of the possibility of excessive heat and hot-roof odor.

6.10.5 Auxiliary Energy

This should include any additional fans, pumps, air-handling units, space conditioning distribution systems, etc.

There is an option to 'Use Default values', which applies to many projects.

- When this box is unchecked, only the Ventilation fan energy and defrost energy are retained. Any pump entries for DHW recirculation, storage load pump, or heating

system circulation pump are removed. (Note: The devices that remain are shown in the WUFI Passive reports under Auxiliary Energy).

DHW recirculation system: Add the DHW pump energy here or use the default value.

On-demand recirculation system for DHW: Please input the pump energy here. There is a quick workaround to determine an average estimate for this value for your project:

1. Go to Distribution>DHW. Input a value of '1' under length of circulation pipes.
2. Then, go back to Distribution>Aux Electricity. Note the value that auto-populates for the 'Norm Demand [W]' of the DHW circulating pump.
3. Then, go back to Distribution>DHW, remove the '1' from the length of circulation pipes.
4. Go back to Auxiliary Energy, un-check the box for 'Use default values', and add a new pump with the 'Norm Demand' power rating noted from the DHW recirculating system in Step 2.

Air-Handling Units/Space Conditioning Distribution: Energy associated with space conditioning distribution networks/fans should be estimated and input here.

- If a heat pump has energy efficiency data following AHRI Standard 1230 or has data for a ducted distribution system, the fan power associated with space conditioning distribution is already accounted for in the efficiency from the datasheet and does not need to be entered separately.
- If fresh air supply is connected to an air handling unit for distribution into bedrooms, the air handling unit fan energy must be input here and assumed to run 8760 hrs/yr. See [Section 3.5.3](#).

Direct Exhaust Bathroom Fans & Makeup Air Fans: Energy associated with fans should be input here as an 'Other' device.

- Energy Demand (norm) [W]: Use fan energy data when available. If no fan energy data is available, use 0.3 W/cfm as a default.
 - o Multiply total airflow (cfm) found on Ventilation/Rooms>Exhaust ventilation by 0.3 W/cfm for [W] entry.
- Run times are based on the assumed run times found under Ventilation/Rooms>Exhaust Ventilation
 - o Convert minutes/yr to khr/yr: $(\text{minutes/yr})/60/1000 = \text{khr/yr}$.

6.10.6 Heating Devices

Heat Pumps

If any heat pump technology is used for space heating, use the 'Heat Pump' device type. Within this device type, there are two options for modeling heat pumps used for space conditioning:

1. Heat Pump Rated Monthly COP: When COP data for two rated ambient temperatures

can be found, use this device type. This takes the monthly heating demand and climate data into consideration to calculate a more accurate COP.

- Generally, air source heat pumps are rated at 17°F and 47°F. By entering the rated performance at both temperatures, WUFI Passive can calculate an annual average heating COP based on the monthly heating demand and climate. This follows Phius' heat pump protocol.
 - If multiple types of heat pumps are provided for a single building, Phius has created a calculator that calculates the weighted efficiency. Download this calculator from the [Resource Library](#).
2. Heat Pump: Use when given a single COP (coefficient of performance) is provided for the heating system and for ground/water source heat pumps. Note that when a single value is given for air source heat pumps, often this is rated at an ambient temperature of 47F, and the entry should be derated if the climate often reaches temperatures below that.
- If only the HSPF given
 - Climate Zones 4 and colder: Phius' HSPF de-rating calculator must be used. Download Heat Pump Protocol kit from [Resource Library](#).
 - Climate Zones 3 and warmer: COP may be estimated as HSPF/3.412.

Boiler or Furnace

These types of systems should be input as "User Defined" devices.

Find the Energy Factor (EF) or thermal efficiency of the model you are using.

- If using an EF, Phius recommends de-rating the EF by a factor of 0.92 (as in RESNET protocol), to account for the discrepancies between the heavy draws used in the DOE water heater testing protocol and the real world. This derated value can be thought of as a % efficiency for the boiler.

Performance Ratio of Heat Generator: Input the inverse of the efficiency (or Energy Factor)

Source Energy Factor: For natural gas, 1.1

If a specification sheet is available containing information to support the detailed entries for the Boiler device, feel free to use the Boiler option. The part-load efficiency curves in LBNL report 42175 may be used as defaults (See Figure 1 in the report for old boilers and Figure 6 for sealed combustion.) [⁵⁰]

⁵⁰ Henderson, Hugh, Yu Joe Huang, and Danny Parker. *RESIDENTIAL EQUIPMENT PART LOAD CURVES FOR USE IN DOE-2*. Berkeley CA: Lawrence Berkeley National Laboratory, 1999. Web. 31 May 2016.

<https://www.osti.gov/biblio/6519>

Wood Stove

These types of systems should be input as “User Defined” devices.

Performance Ratio of Heat Generator: Input the inverse of the efficiency (ie. $1/60\% = 1.67$)

Source Energy Factor: For biomass fuel, 0.2

A typical “off the shelf” wood stove is likely oversized for single family passive buildings. If using this system for a portion of heating, as a default, assign 25% heating coverage. If using a system designed for a lower heat load or a more low-steady heating system, such as a masonry heater or pellet stove, it may be plausible to increase the % coverage. For efficiency, an estimate of 60% should be used unless supporting documentation can be provided to confirm a higher efficiency.

6.10.7 Domestic Hot Water Devices

Heat Pump Water Heaters

- With Indoor Compressors:
 - In the Systems branch, add a ‘Heat Pump’ device.
 - Select ‘Heat Pump water heater (HPWH) inside’ as the device type. This will de-rate the efficiency of the HPWH heater to account for the heating systems working against each other in the heating season.
 - Enter the heating system COP or efficiency
 - Total System Performance Ratio: Enter $\frac{1}{\text{Heating System COP}}$ as a decimal.
 - HPWH EF: Enter the rated Energy Factor (EF) for the Heat Pump Water Heater
 - If Uniform Energy Factor (UEF) is provided
 - HPWH EF = $1.201 * \text{UEF} - 0.6052$
- With Outdoor Compressors:
 - In the Systems branch, add a “Heat Pump” device.
 - Select ‘Heat Pump’ as the device type.
 - Supplemental calculators that take the local climate into effect can be found on the [Resource Library](#).
 - The climate-adjusted Energy Factor (EF) of the specified model should be used
 - Total System Performance Ratio: Enter $\frac{1}{\text{Adjusted Energy Factor}}$ as a decimal.
- Sanden CO2 Heat Pump Water Heater or other HPWH with outdoor compressor and indoor water storage.
 - In the Systems branch, add a ‘Heat Pump’ device in WUFI Passive
 - Select ‘Heat Pump’ as the device type.
 - Supplemental calculators that take the local climate into effect can be found on the [Resource Library](#).
 - The climate-adjusted Energy Factor (EF) of the specified model should be used

- Total System Performance Ratio: Enter $\frac{1}{\text{Adjusted Energy Factor}}$ as a decimal.

Water Heaters with Tank

- Gas-Fired: Input as a User Defined device & include water storage as a system.
 - If UEF provided, convert to EF using the calculation below.
 - $EF = 0.9066 * UEF + 0.0711$
- Electric:
 - If the UEF is provided, input as a 'User Defined' device, convert to EF using the calculation below, use Phius' electric source energy factor & do not include water storage as a system.
 - $EF = 2.4029 * UEF - 1.2844$
 - If no UEF or EF is provided, choose electric and add water storage as a system.

Water Storage

- Enter as a 'Water Storage' device and check the box for 'DHW'.
- Input Options: Choose options based on documentation available.
 - Specific total losses (Btu/hr.F): If AHRI standby loss (F/hr) data available, calculate using the formula below.
 - $8.3454 * \text{Tank Size (gal)} * \text{Standby Loss (F/hr)}$
 - Specific losses standby part only (Btu/hr.F): Least common options and requires part-load standby loss data.
 - Total losses (Btu/hr): If AHRI standby Loss (F/hr) data available, calculate using the formula below.
 - $\frac{[8.3454 * \text{Tank Size (gal)} * \text{Standby Loss (F/hr)}]}{[\text{Typical Water Storage Temperature (F)} - 68 (F)]}$

Tankless Water Heaters

- Gas-Fired: Enter the same as Gas-Fired Water Heater, but UEF = EF; do not add water storage as a system.
- Electric: Enter the same as Electric Water Heater, but UEF = EF or choose electric heating; do not add water storage as a system.

Solar Collector

- In cases where the energy model report shows a solar fraction above 65%, we require a predicted annual output from the solar inspector as to the kBtu/yr energy production; OR
 - A BEopt model run according to the Phius Solar DHW Fraction BEopt Protocol. This protocol can be downloaded [here](#).

Ground Source Heat Pump

- Enter as a 'Heat Pump' device and use the rated COP at the appropriate entering and exiting water temperatures.
- Any pump energy that is not included in the COP of the system should be added as an auxiliary energy device.

6.10.8 Mechanical Ventilation Devices

Sensible Recovery Efficiency, Humidity Recovery Efficiency, Electric Efficiency:

- Phius accepts ventilator efficiency data from five sources. The sources are listed below in priority order of acceptable data. If data is available for a product from two sources on the list, the data from the source listed first is given priority.
 - o [Phius Certified Ventilator Program](#)
 - This program is still in development.
 - o [Home Ventilation Institute \(HVI\)](#)
 - [Section 3 Directory](#) lists individual ventilators up to ~300 cfm.
 - Use the Adjusted Sensible Recovery Efficiency (ASRE) or the Adjusted Total Recovery Efficiency (ATRE).
 - For climate zones 3C and colder, use the ASRE HEATING rating at 32°F (0°C).
 - For climate zones 3B and warmer, use the ATRE COOLING rating at 95°F (35°C).
 - Testing data at multiple airflows may be available, round up to the airflow of the nearest data point that aligns with the planned airflow for the project.
 - o Air-Conditioning, Heating, and Refrigeration Institute (AHRI)
 - AHRI Standard 1060 based simulation data should be used.
 - Ratings for commercial units do not include electrical efficiency data. For design certification calculations, estimate electrical consumption from manufacturer's specifications. This can be done by dividing the fan power by the design flow rate of air.
 - o [Passivhaus Institut \(PHI\) Certified Component Data](#) (PHI)
 - May be used as long as the planned airflow for the project is within the range listed on the certificate.
 - Ensure the data available aligns with the ventilator chosen for the project. If the humidity recovery is 0% on the data provided, it is for the HRV core of that device. If the ERV core of the device is specified for the project, the PHI data shall not be used.
 - o Individual Manufacturers
 - If no 3rd party verification data is available, the stated manufacturer efficiency minus 12 percentage points shall be used.
- At final certification, if the exhaust or supply air flow exceeds the exhaust air flow by more than 10%, the associated additional infiltration or exfiltration must be accounted

for. It will be assumed that this unconditioned airflow will be continuous at the same rate as the difference between the supply and exhaust air flows.

- (1) In WUFI Passive, this should be added under 'Ventilation Rooms>Exhaust Ventilation' as an 'other exhaust appliance' running for 525,600 minutes/year..

Latent/Humidity Recovery Efficiency: If this value is not specified for the ERV, 40% may be entered as a default. For an HRV, enter 0%. When a project falls under the summer test conditions (Climate zones 1A,2A,2B,3B), then request the HRV manufacturer provide their CSA 439 summer test point data. You can use this to break out ASE and LR. You will see that most projects should use the HVI's winter test point data. Only the 2B and 3B zones will use different test data for the ASE and LR inputs.

CERV from Build Equinox:

Default values may be used for performance of refrigerant-based heat recovery devices. Or, Phius-approved calculation methodology may be used to determine performance entries.

- Default accepted values:
 - o Sensible Heat Recovery: 75%
 - o Latent Heat Recovery: 40%
 - o Electric Efficiency: 1 W/cfm

PentaCare V12 from MINOTAIR:

This system requires dynamic (hourly) climate data and project specific calculations to determine the performance values for WUFI Passive modeling. [Contact Us](#) and provide the project number and Phius climate location used to receive the Phius calculator needed for project certification.

Assigning 'rooms ventilated by this unit': If multiple ERVs are used, the rooms assigned to each unit need to appropriately be assigned to their corresponding ERV. The list of rooms shown here is populated based on the entries on the Ventilation/Rooms branch. For the example below, ERV Type X would check the boxes for all the residential exhaust rooms. ERV Type Y would check the boxes for all common space exhaust rooms.

Quantity: When using multiple identical ERVs in one building, a single 'Mechanical ventilation' device in WUFI Passive can cover all of them. For example, if the project is a 50-unit MF building with 50 identical ERVs "Type X", this can be modeled as a single device, ERV Type X, and the quantity would be adjusted to 50.

- This applies when the identical ERVs are scheduled to run at roughly the same airflow rates, and therefore would have similar rated efficiencies (refer to [HVI Directory 3](#) document above for more information on rated efficiencies at different airflows).
- Because you have increased the quantity of ventilation units under the device, do not increase the quantity of ventilation ducts under Systems>Distribution (see [Section 6.10.4](#)). This may cause the duct losses to be overcounted.

- New mechanical ventilation devices only need to be added when a new unique ERV/HRV type is used in the project. For example, in a MF building, the residential units are served by ERV Type X, and the common spaces are served by ERV Type Y.

HRV/ERV in conditioned space: If the ventilation unit is located outside of the thermal envelope in an unconditioned space (ie. Rooftop), uncheck this box and amend the Mechanical Room Temperature under PH Case: Additional Data using the E/HRV Outside calculator found in the [Resource Library](#).

- Software bug note: WUFI Passive cannot currently account for a mix of ventilation units and inside and outside the thermal envelope. If any ventilator has the box for 'HRV/ERV in conditioned space' checked, WUFI Passive assumes all of the ventilators in the model are in conditioned space. For certification modeling purposes, the following protocol should be followed.
 - If 50% or more of the planned average airflow through the outdoor air ventilation system with heat recovery is within the thermal envelope, check the box for 'HRV/ERV in conditioned space' for all ventilation units.
 - If less than 50% of the planned average airflow through the outdoor air ventilation system with heat recovery is within the thermal envelope, uncheck the box for 'HRV/ERV in conditioned space' for all ventilation units and follow the instructions above to update the Mechanical Room Temperature under PH case.

Defrost: No matter the method of defrost, Phius requires accounting for defrost energy and entering between 23°F-28°F for the temperature in which defrost must be used.

- If using a ground loop pre-heater/subsoil heat exchanger, defrost energy does not need to be accounted for in the energy model.

Subsoil Heat Exchanger: Use for earth air tubes and liquid-based ground loops for tempering supply air. Typical efficiency ranges from 40-60%. For entries above 60% efficiency, a corresponding calculation is required for certification.

6.10.9 Renewable Energy Systems

For any renewable energy, on-site or off-site, add a 'Photovoltaic / renewable energy' device.

- Name: Use a descriptive name for the device - recommend including the manufacturer (if available) and array size (kW and area)
- Location:
 - Phius CORE projects may only utilize on-site renewables
 - Phius ZERO projects may use a combination of on-site and off-site renewables.
- Add a new device for each unique type of renewable energy.

| Location | Type | kWh/yr | CORE | ZERO |
|----------|--|----------------------|----------------------------|------|
| | | | Onsite Utilization | |
| On-Site | On-Site Renewable Energy | Varies ⁵¹ | PV utilization calculator* | 1 |
| Off-site | Directly Owned Off-site Renewable Energy | Varies | N/A | 0.75 |
| | Community Renewable Energy | Varies | N/A | 0.75 |
| | Virtual Power Purchase Agreement | Varies | N/A | 0.75 |
| | Renewable Energy Certificates (RECs) | Varies | N/A | 0.2 |

*For Phius CORE projects that employ on-site renewables, V3.3.0.2 of WUFI Passive Passive has a built-in version of the [On-Site PV Production Utilization Calculator](#).

For design certification, on-site renewable energy must be documented. For any off-site renewable energy, Phius will ask that the project owner signs a letter of intent for contracting enough renewable energy before final certification is awarded.

6.10.10 Drain Water Heat Recovery

The drain water heat recovery device is used to adjust the temperature of the incoming water supply by recovering warm drain water and pre-heating the incoming cold freshwater.

Note: DWHR device does not work in combination with the 'Simplified individual pipes' hot water distribution calculation method.

DW heat recovery unit indoor temp: Default 97F

DW Heat Recovery Unit Efficiency: As rated and labeled in accordance with CSA 55.1

Pipe Length: Measured length of hot water piping from the hot water heater to the farthest hot water fixture. Measured longitudinally from plans, assuming the hot water piping does not run diagonally. Plus 10 feet of piping for each floor level, plus 5 feet of piping for unconditioned basements (if any).

Supplies pre-heated water to: Select if the system supplies both hot and cold water, or just one of the two.

⁵¹ [NREL's PV Watts Calculator](#) is an accepted method for estimating annual energy production from an on-site PV Array. Please include a PVWatts report in document submission

6.10.11 Electric Vehicle Charging

It is not required to include the EV charging station in the WUFI Passive energy model used for certification compliance. The energy use from the car charger is categorized as transportation energy and not included in the source energy limit for Phius Certification.

6.11 WUFI Passive Reports

Reports are automatically generated upon completion of a WUFI Passive model. If results are present, the reports are available. Reports can be printed to PDF or exported into Microsoft Word. If exported into MS Word, charts can easily be copied into Excel if needed.

Scope:

- Passive House Verification: Comprehensive summary of results and verification of compliance for all performance-based certification requirements, verification of compliance with Phius' add-on badges, breakdown of losses and gains for calculation of annual demands and peak loads, electricity & DHW consumption, etc.
- REM-Rate Report: Summary report for Phius Certified Rater/Verifier to view for coordination with REM/Rate model.
- Site Energy Report: Breakdown of site energy by end use.
- Source Energy Report: Breakdown of source energy by end use.
- Site Energy Monthly Report: Breakdown of monthly site energy by end use. Supports comparison of energy model results to monthly utility bills. Available in PHIUS+ 2018 and Phius 2021 modes. Currently only available in residential mode.
- User Defined: Combines all reports into one, long report.

View Settings

- Normal: Used for viewing within WUFI Passive. Does not have headers or page numbers.
- Print/Export Layout: Includes a header, page numbers, and a footer which includes the case name on each page of the report.

Note: Select WUFI Passive Options > Usability > 'Show project/case in footnote'

7. Monitoring

Post occupancy energy monitoring is highly recommended, however, Phius does not require it for certification. A main reason for this is because it is highly dependent on occupant behavior. Phius certifies projects based on values that assume how occupants would behave, but most times occupant behavior cannot be controlled by the designer.

By gathering actual performance data – in the form of utility bills or from monitoring systems – Phius can improve modeling protocols and refine the practices used by all parties involved in

the certified project, including component manufacturers. This may also provide insight into the intricacies of climate specific design and its financial implications for the passive building owner.

7.1 Monitoring Protocol

Phius has released draft monitoring protocol which defines background information on:

- The purpose of monitoring
- Research questions that guide selection of data points to monitor
- Various tiers of equipment to use based on project budget
- Roles and responsibilities of planning and executing a successful monitoring plan from design through construction to post occupancy.

The monitoring protocol will continue to develop as Phius gains more insight and experience on collecting data from certified projects.

7.2 Monitoring Your Project

[Contact Us](#) if:

1. You have a project in design-phase that is interested in participating in Phius' monitoring program.
2. You are willing to share monitored data for a Phius Certified project.
 - If 1+ years of utility bills are available, Phius will provide a free analysis of the predicted vs. actual performance based on the WUFI Passive energy model.

8. Additional Certification Badges

Additional recognition will be given to project designs that meet the regular requirements and achieve any of the following performance goals.

8.1 Supply Air Heating and Cooling Sufficient

The design allows for adequate delivery of heating and cooling via ventilation supply air only per WUFI Passive static calculation, with average design ventilation rate no more than 0.4 ACH. This is accomplished with low peak load design.

The 'Passive House Verification' Report in WUFI Passive can verify compliance with this add-on badge.

Appendix A – Renewable Energy

From ASHRAE 189.1-2017 Addendum J, Phius markup

A-1 Renewable Energy Systems

For **Phius CORE**, the adjusted renewable energy provided to the project can be used to offset source energy use and meet the source energy performance limit. Note that only on-site energy is credited, per adjustment factors in A-2.

For **Phius ZERO**, the adjusted renewable energy provided to the project shall be equal to or greater than the modeled energy use.

Documentation shall be provided to Phius that substantiates procurement of renewable energy systems, of renewable energy contracts, or of a quantity of RECs required to meet the Exception to A-1 RECs shall be tracked in accordance with Section A-4.

Qualifying renewable energy systems are as follows:

1. On-site renewable energy system
2. Off-site renewable energy system
 - a. Self-generation (an off-site renewable energy system owned by the building project owner). The system shall comply with Section A-3.
 - b. Community renewable energy facility—The system shall comply with Section A-3.
 - c. Purchase contract—The system shall comply with Section A-3.
 - d. Contract for renewable electricity products complying with the Green-e Energy National Standard for Renewable Electricity products of not less than 100% of the modeled annual energy use multiplied by 20 years. A combination of renewable electricity products and renewable energy systems shall be permitted to demonstrate compliance. RECs shall be tracked per Section A-4.

A-2 Adjusted Renewable Energy

Each source of renewable energy delivered to or credited to the building project shall be multiplied by the factors in Table A-2 when determining compliance with Section A-1.

Table A-2: Multipliers for Renewable Energy Procurement Methods

| Location | Renewable Energy Source | Renewable Energy Adjustment Factor | |
|----------|---|------------------------------------|------|
| | | CORE | ZERO |
| On-Site | On-Site Renewable Energy System | Varies ⁵² | 1.00 |
| Off-Site | Directly Owned Off-Site Renewable Energy System | N/A | 0.75 |
| Off-Site | Community Renewable Energy System | N/A | 0.75 |
| Off-Site | Virtual PPA | N/A | 0.75 |
| Off-Site | Green-e RECs | N/A | 0.20 |

A-2.1 Accounting Table for Source Energy Offset by Adjusted Renewable Energy

The annual net source energy for a building is calculated by multiplying the site energy by the fuel-dependent source energy factor, and then subtracting the adjusted renewable energy production multiplied by the fuel-dependent source energy factor of the fuel type it is offsetting.

| Phius CORE | Annual Renewable Energy Production (kWh/yr) | Adjustment Factor | Grid-Electricity Source Energy Factor | Offset to Source Energy |
|---------------------------------|---|-------------------|---------------------------------------|-------------------------|
| On-Site Renewable Energy System | | ✗ Varies | ✗ | ≡ |
| TOTAL | - | - | - | |

⁵² Between 0-1, based on an estimate of coincident production-and-use of the predicted annual onsite-renewable electricity generation. For rooftop PV, Phius has pre-defined utilization curves that are used to determine this value. On-site energy storage may be used to increase this utilization factor and requires a custom calculation.

| Phius ZERO | Annual Renewable Energy Production (kWh/yr) | Adjustment Factor | Grid-Electricity Source Energy Factor | Offset to Source Energy |
|---|---|-------------------|---------------------------------------|-------------------------|
| On-Site Renewable Energy System | X | 1 | X | ≡ |
| Directly Owned Off-Site Renewable Energy System | X | 0.75 | X | ≡ |
| Community Renewable Energy System | X | 0.75 | X | ≡ |
| Virtual Power Purchase Agreement | X | 0.75 | X | ≡ |
| Green-E Certified RECs | X | 0.2 | X | ≡ |
| TOTAL | - | - | - | |

A-3 Off-Site Renewable Energy Requirements

Off-site renewable energy delivered or credited to the building project to comply with Section A-1 shall be subject to a legally binding contract to procure qualifying off-site renewable energy.

Qualifying off-site renewable energy shall meet the following requirements:

1. Documentation of off-site renewable energy procurement shall be submitted to Phius.
 - a. Procurement plan is required for review and approval during Phius' Design Certification phase.
 - b. Contract as described below is required for review and approval during Phius' Final Certification phase.
2. The purchase contract shall have a duration of not less than 15 years. The contract shall be structured to survive a partial or full transfer of ownership of the building property.
3. RECs associated with the purchase contract from an off-site renewable energy shall be assigned exclusively to the building owner for a period of not less than 15 years and tracked in accordance with Section A-4.
4. The energy source shall produce electricity from solar, wind, or geothermal energy.

Exceptions:

- a. Captured methane from feed-lots and landfills are permitted to be used to generate electricity for the purposes of this section.
 - b. Hydropower from new generation capacity on a non-impoundment or new generation capacity on an existing impoundment that meets one of the following conditions:
 - i. The hydropower facility complies with the Low Impact Hydropower Certification Handbook and is certified by a nationally recognized accreditation organization.
 - ii. The hydropower facility complies with UL 2854 and is certified by an organization that has the standard in its ISO 17065 scope of accreditation.
 - iii. The hydropower facility consists of a turbine in a pipeline or a turbine in an irrigation canal. For facilities falling under either Exception, only output generated during the period of certification is eligible for RECs sale in accordance with the provisions of this section. Renewables from new impoundments of water are not eligible.
5. The generation source shall be located where the energy can be delivered to the building site by any of the following:
 - a. By direct connection to the off-site renewable energy facility
 - b. By the local utility or distribution entity
 - c. By an interconnected electrical network where energy delivery capacity between the generator and the building site is available (Informative Note: Examples of interconnected electrical networks include regional power pools and regions served by Independent System Operators or Regional Transmission Organizations.)
6. Records on renewable power purchased by the building owner from the off-site renewable energy generator that specifically assign the RECs to the building owner shall be retained or retired by the building owner on behalf of the entity demonstrating financial or operational control over the building seeking compliance to this standard and made available for inspection by Phius upon request. (Informative Note: Refer to Sections A-4 and A-5 for tracking and allocation requirements.)
7. Where multiple buildings in a building project are allocated energy procured by a contract subject to this section, the owner shall allocate for not less than 15 years the energy procured by the contract to the buildings in the building project. (Informative Note: Refer to Section A-5 for allocation requirements.)

A-4 Renewable Energy Certificate Tracking

The plan shall include provisions to use a REC tracking system that meets the requirements of Section V.B of the Green-e Framework for Renewable Energy Certification. The plan shall describe how the building owner will procure alternative qualifying renewable energy in the case that the renewable energy producer ceases operation.

A-5 Renewable Energy Allocation to Multiple Buildings

Where renewable energy is allocated to multiple buildings in compliance with Section A-3 (7), the plan shall indicate how renewable energy produced from on-site or off-site systems that is not allocated before issuance of the certificate of occupancy will be allocated to new or existing buildings included in the building project. The plan shall indicate who will be responsible for retaining the documentation for allocations and where it will be stored so that it can be made available for inspection by Phius upon request.

Where multiple buildings in a building project share a common utility interconnection and are served by the same on-site renewable energy system, the building owner shall allocate for not less than 15 years the annual REC generation of the on-site renewable energy system to the buildings served by the system. The annual generation vintage date of delivered RECs shall be allocated to the same 12-month reporting year, up to six months prior, or up to three months after the calendar year in which the electricity is used in the building. The annual allocation of RECs shall be documented as part of the plan. The plan shall indicate who will be responsible for retaining the documentation and where it will be stored so that it can be made available for inspection by Phius upon request.

Appendix B – Moisture Control Guidelines for Opaque Assemblies

Excerpted from Straube (2012), Section 3.4.1, with some revisions.

Different types of assemblies have different vapor control requirements. Although the requirements can be developed through rational engineering analysis, a simplified summary of recommendations, many from the “I” codes, is presented below.

B-1 General Moisture Control Guidelines

There are three compliance paths:

- Follow the prescriptive moisture control guidelines listed in this [Appendix B](#).
- Meet performance criteria by WUFI hygrothermal analysis, according to the protocol [found here](#) (fee may apply, see also [Section 5.4](#)). More in [Appendix I-3](#).
- Present a moisture-engineered design by a qualified licensed professional engineer.

Assemblies that do not fit the prescriptive category descriptions do not have a prescriptive path.

Exterior load-bearing double-stud walls do not have a prescriptive path.

Floors with more than 2.5 inches (5 cm) of air-permeable insulation or acoustic material do not have a prescriptive path, unless they are suspended floors accessible from below for repair, and are not subject to bulk water events per plumbing plans, in which case the vapor control requirements for walls apply.

B-1.1 Things to Avoid

In general, Phius recommends against using **wet spray cellulose**.

“Vapor-sandwiched” or “double vapor barrier” assemblies: These should generally be avoided and can make a project uncertifiable. There are some subtleties, e.g., it may be acceptable in compact roof assemblies. See these articles for a more detailed discussion [BSI-073] [BSI-092]. That discussion starts with “For the record, it makes no sense to have a vapor barrier on both sides of an assembly. If the assembly gets wet or starts out wet, we are pretty much doomed...except if we are perfect and we start out dry.”

[Building Science Corporation BSI-073: Macbeth Does Vapor Barriers](#)

[Building Science Corporation BSI-092: Doubling Down-How Come Double Vapor Barriers Work?](#)

B-2 Moisture Control Guidelines for Walls

B-2.1 Above-Grade Wall Assemblies

Four categories of above-grade wall assemblies include most of the possible enclosures:

- a) Framed assemblies with all or most of the insulation inside of the sheathing and between the framing members,
- b) Framed assemblies with some insulation outboard of the framing and some insulation between the framing members,
- c) Assemblies with all or most of the insulation outboard of the structure (framed or solid), and
- d) Assemblies with insulation comprised only of air-impermeable and Class II vapor control insulation between, within, or outside of the structure.

a) Framed wall assemblies with all or most of the insulation value installed between the framing or structure (e.g. wood or steel stud) as vapor permeable (more than 10 perm) insulation (e.g., fiberglass, rockwool, cellulose, or open cell foam).

The goal of the vapor control design is to prevent vapor diffusing easily and condensing on either the cold sheathing in cold weather or the cold interior finish during warm weather.

- No vapor control layer is needed in climate zones 1,2,3,4a or 4b.
 - Smart membranes such as Membrain & Intello are not recommended in hot/humid⁵³ and mixed/humid⁴⁰ climates.
- A Class I or Class II vapor control layer is required on the interior side of framed walls in zones 4c, 5, 6, 7, and 8, with the exceptions of basement walls, below-grade portion of any wall, and wall construction that is not sensitive to moisture or freezing (e.g., concrete).
- Class I vapor control layers including non-perforated vinyl wallpaper, reflective foil, glass, epoxy paint, white boards, melamine, etc. are not recommended and should be avoided on the interior of air-conditioned building occupancies in climates with humid summers in zones 1-6. The dividing line between dry (B) and moist (A) can be found in ASHRAE 90.1. Enclosures clad with unvented water absorbent claddings (e.g., stucco, masonry,

⁵³ The climate zones noted here are defined by the [Building America Zoning](#) system.

fiber cement, wood) are at especially high risk of summer condensation.

- A Class III vapor retarder can be used instead of a Class I or Class II when:
 - In zones 4c, or 5, vented cladding is used over sheathing with a perm rating of more than 1 (wet-cup), i.e., OSB, plywood, or exterior gypsum sheathing; or
 - In zone 6, vented cladding is used over high permeance (more than 10 perm) sheathings such as fiberboard and exterior gypsum.

Vented claddings include vinyl siding, metal panels, terra cotta, wood or fiber cement sidings on air gaps, and masonry veneers with clear airspaces and vent openings top and bottom. A clear gap of around $\frac{3}{8}$ " (10mm) will generally provide sufficient airflow to allow for ventilation, but at least 1" (25mm) should be specified for masonry walls.

Exterior Load Bearing Double-Stud Walls

This wall type is discouraged in climate zones 3 and higher. They tend to be too vapor-closed on the outside for those climates and put the air barrier on the exterior where it will be less durable than a mid-wall air barrier.

These will generally incur additional certification cost for hygrothermal analysis (WUFI).

If they are of the "flash and fill" type and insulation with a high global warming potential is used (some closed cell spray foam or XPS), PHIUS may ask the project team to complete a [global warming potential calculation](#) to assess the overall impact of the insulation.

In heating dominated climates, double stud walls should be of the interior load-bearing type, either Larsen truss (standoff truss) or the kind described in [⁵⁴], [⁵⁵].

b) Framed assemblies with some insulation value outside of the framing or structure.

⁵⁴ "ETW: Wall - Double Stud Wall Construction." Building Science Corporation, 15 Nov. 2014. Web. 16 May 2016.

<http://buildingscience.com/documents/enclosures-that-work/high-r-value-wall-assemblies/high-r-value-double-stud-wall-construction?topic=doctypes/enclosures-that-work/etw-high-r-value-enclosure-assembly>

⁵⁵ Bailes III, Allison A. "Lstiburek's Ideal Double-Stud Wall Design." Green Building Advisor. The Taunton Press, 29 Apr. 2015. Web. 16 May 2016.

<http://www.greenbuildingadvisor.com/articles/dept/building-science/lstiburek-s-ideal-double-stud-wall-design>

The use of insulation on the exterior of the sheathing increases its temperature in cold weather, thereby relaxing the need to control cold-weather vapor diffusion. Exterior insulation made of foamed plastic has the benefit that it also tends to reduce inward vapor drives during warm weather. MFI insulation work different in that they allow more outward drying.²⁴

A Class III vapor control layer shall be used on the interior of framed walls in zone 4c and higher, and any of the following criteria met:²⁵

- Zone 4c (e.g., Vancouver, Seattle, or Portland)
 - Sheathing-to-cavity R-value ratio of >0.20
 - Insulated sheathing with an R-value >2.5 on a 2x4 framed wall
 - Insulated sheathing with an R-value >3.75 on a 2x6 framed wall
- Zone 5 (e.g., Chicago, Windsor, Boston)
 - Sheathing-to-cavity R-value ratio of >0.35
 - Insulated sheathing with an R-value ≥ 5 (e.g., 1" XPS) on a 2x4 framed wall
 - Insulated sheathing with an R-value ≥ 7.5 (e.g., 1.5" XPS) on a 2x6 framed wall
- Zone 6 (e.g., Toronto, Ottawa, Helena, Montreal, Halifax, Minneapolis)
 - Sheathing-to-cavity R-value ratio of >0.50
 - Insulated sheathing with an R-value ≥ 7.5 (e.g., 1.5" XPS) on a 2x4 framed wall
 - Insulated sheathing with an R-value ≥ 11.25 (e.g. 2" PIC) on a 2x6 framed wall
- Zones 7 and 8 (e.g., Calgary, Edmonton, Whitehorse, Anchorage, Fairbanks)
 - Sheathing-to-cavity R-value ratio of >0.70
 - Insulated sheathing with an R-value \geq (e.g., 2" XPS) on a 2x4 framed wall
 - Insulated sheathing with an R-value \geq (e.g., 3" XPS) on a 2x6 framed wall

Insulated sheathing can be installed in the form of expanded polystyrene (EPS) or semi-rigid glass fiber and rockwool with approximately R-4 per inch, extruded polystyrene (XPS) with R-5 per inch, polyisocyanurate (PIC) with approximately R-6 per inch or closed-cell spray foam (usually around R-6/inch).

Note & example: For walls, the sheathing-to-cavity R-value ratio is specified. This is different from the roof, which specifies a sheathing R-value as a percentage of the total assembly R-value.

For CZ 5 Wall Sheathing-to-cavity R-value ratio > 0.35. To achieve this, determine the R-value of the cavity insulation (R-21 for example) and multiply this by 0.35 to determine the minimum R-value from the continuous insulation R-7.35. $R-7.35 [CI] / R-21 [cavity] = 0.35$. To meet the ratio, the exterior continuous insulation should have an R-value > R-7.35.

c) Assemblies with all or most (more than 75% of the total) of the insulation value located outboard of the structure (framing or solid).

This is the simplest and most robust wall to design with respect to vapor control. Such walls should ideally have all moisture sensitive components and materials located on the inside of

the insulation. In this location, a Class I or II layer on the inside of all or most of the insulation value is acceptable and recommended if all outboard components are moisture tolerant.²⁶ A Class III layer on the interface of a high permeance (more than 10 perms) insulation layer outboard of a moisture-sensitive structure should only be used if warm weather and inward vapor drive condensation are not an issue or are controlled by other means.

d) Assemblies comprised of only air-impermeable and Class II vapor control insulation between, within, or outside the structure.

The EPS and urethane foam cores of wood or metal SIPS, board foams, and medium density closed cell spray foam (between wood or steel studs), if installed as continuous layers, all provide their own vapor control layers and require no additional vapor-diffusion control in any climate. Wood studs and small cracks between steel or wood studs do not allow significant vapor to flow by diffusion. Their use does not change the recommendations.

Cracks between framing members and insulation boards are often significant for airflow control and must be addressed in all the systems described in the previous paragraph.

B-2.2 Below-Grade Wall Assemblies

Below-grade spaces, such as basements, are of particular concern with respect to improperly located Class I vapor control layers. Because the moisture drive in below-grade walls is always from the exterior to the interior in zones 6 and lower, installing a low-permeance layer on the interior side of insulation will cause moisture related durability issues by trapping moisture in the enclosure. A Class I vapor control layer outside a concrete or masonry basement wall is recommended to control the flow of vapor from damp soil into the assembly. Installing a Class II vapor control layer on the inside of below-grade framed assemblies is recommended for zones 7 and higher.

In cold climates (zone 5 and higher), condensation may occur on the interior side of concrete/masonry structure of a below-grade wall assembly if insulated on the inside with an air and vapor permeable (Class II or more, e.g., fibrous insulation) layer. To control both inward and outward drives, it is recommended that a Class II or III insulation product (e.g. most foams) be used in contact with the interior face of the concrete/masonry, and any insulation installed between interior framing follow the rules of “Framed assemblies with some insulation value outside of the framing or structure.”

B-2.3 Masonry Walls and Freeze-Thaw

Interior insulation retrofits of masonry walls in cold climates can cause durability problems. Please review the information in these articles: [⁵⁶] [⁵⁷] [⁵⁸] Certification staff may require a “hold harmless” agreement.

B-3 Moisture Control Guidelines for Roofs

Roofing behaves differently than walls from a vapor control point of view for several reasons: most roof membranes are located on the exterior and provide Class I vapor control. Roof membranes, shingles, metal roofing are all vapor impermeable. Only back-ventilated roofing such as concrete ties perform in a similar manner to walls.

Assuming a vapor impermeable roofing membrane, four categories of roof assemblies will include most practical roofing systems:

- a) Unvented roof assemblies with all or most of the insulation outboard of the structure (framed or solid),
- b) Vented, framed roof assemblies with all or most of the insulation inside of the sheathing and between the framing members,
- c) Unvented, framed roof assemblies with either some insulation outboard of the framing and some insulation between the framing members, or some air-impermeable insulation outboard of air-impermeable insulation, and
- d) Unvented roof assemblies with insulation comprised of air-impermeable and Class II vapor control between, within, or outside the structure.

⁵⁶ Straube, John, and Chris Schumacher. “Interior Insulation Retrofits of Load-Bearing Masonry Walls in Cold Climates.” *Journal of Green Building* 2.2 (2007): 42–50. Web. 31 May 2016.

https://www.researchgate.net/publication/269493678_Interior_Insulation_Retrofits_of_Load-Bearing_Masonry_Walls_in_Cold_Climates

⁵⁷ Lstiburek, Joseph. “BSI-011: Capillarity—Small Sacrifices.” Building Science Corporation, 3 June 2014. Web. 31 May 2016.

<http://buildingscience.com/documents/insights/bsi-011-capillarity-small-sacrifices>

⁵⁸ “BSI-095: How Buildings Age.” Building Science Corporation, 13 May 2016. Web. 31 May 2016.

<http://buildingscience.com/documents/building-science-insights/bsi-095-how-buildings-age>

a) Unvented roof assemblies with all or most (>75%) of the insulation outboard of the structure (framed or solid).

These types of roofs comprise most of the low-slope, rigid board insulated; commercial roof systems installed over metal and concrete decks. However, there is no technical difference between a low-slope roof built in this manner and a sloped roof. This type of roof has very little need for additional vapor control as all the common board foam roofing insulations (PIC, EPS, XPS) provide sufficient vapor control for most climate zones.

- No additional vapor control layer is needed if a Class II vapor control insulation layer is used (>2" of XPS, PIC, >3" of EPS).
- To control diffusion at joints in board foam, all board insulation should be installed in two layers or more, with joints offset vertically and horizontally. This is especially important in zones 5 and higher.

Such roofs should ideally have all moisture sensitive components and materials located to the inside of the insulation. In this location a Class I or II layer on the inside of all or most of the insulation value (e.g., 75%) is acceptable but will restrict desirable and effective inward drying. For zones 5 and lower, a vapor control layer of Class III or higher is recommended to allow for inward drying of incidental moisture due to solar heating to roof membranes (e.g., gypsum board on metal deck).

b) Vented, framed roof assemblies with all or most of the insulation value installed between the framing (e.g., wood/steel stud, metal buildings) as vapor permeable (more than 10 perm) insulation (e.g., fiberglass, rockwool, cellulose, or open cell foam).

If a compact roof is well-vented above the insulation (i.e., with soffit and ridge vents connected by an open air-space of 1.5"/38mm or more) or a compact roof is well-vented above vapor semi-permeable or permeable sheathing (OSB or plywood etc...) which is outboard of vapor permeable insulation:

- No vapor control layer is required in zones 1 through 3
 - o Smart membranes such as Membrain & Intello are not recommended in hot/humid⁵⁹ and mixed/humid⁴¹ climates.
- Class III vapor control in zones 4 through 6
- Class II vapor control in zones 7 and higher

⁵⁹ The climate zones noted here are defined by the [Building America Zoning](#) system.

If a roof is sloped over a well-vented attic (i.e., with soffit and ridge vents connected by an open-air volume of at least 12" (300mm) average height, and no less than 1.5"/38mm anywhere):

- No vapor control layer is required in zones 1 through 4.
- Class III vapor control layer is recommended for zones 5 through 6.
- Class II vapor control layer is recommended in zones 7 and higher.

Unvented, framed assemblies with all the insulation value comprised of air permeable insulation (fiberglass, rockwool, cellulose) between the framing are not recommended due to the potential for air leakage condensation.

c) Unvented framed roof assemblies with some insulation provided by air impermeable and Class II vapor retarding insulation.

Roofs need not be vented if diffusion and air leakage related wetting can be strictly limited. To accomplish this, some air impermeable, some Class II insulation can be located outside of air and vapor permeable (more than 10 perm) insulation (e.g., fiberglass, rockwool, and cellulose are both).

The ratio of the insulation value of the exterior air- and vapor-control insulation to the insulation value of the interior air- and vapor-permeable insulation increases as the climate becomes colder, and the interior more humid. For normal commercial and residential occupancies, the following recommendations can be made.

(Note: painted drywall or more than about 150mm/6" of open cell foam are Class III retarder)

- For zones 1 through 3A, 3B
 - Outer air-impermeable insulation value >15% of total
 - No vapor control layer required.
- For zones 3c/4c (e.g. Vancouver, Seattle, Portland, San Francisco)
 - Outer air-impermeable insulation value >25% of total
 - Class III vapor control
- Zone 4A, 4B, 5 (e.g. Windsor, Kansas City, Boston)
 - Outer air-impermeable insulation value >35% of total
 - Class III vapor control in zone 5
- Zone 6 (e.g. Toronto, Ottawa, Montreal, Halifax, St Johns, Minneapolis)
 - Outer, air-impermeable insulation value >50% of total
 - Class III vapor control
- Zones 7 and 8 (e.g. Edmonton, Calgary, Winnipeg, Whitehorse, Fairbanks)
 - Outer, air-impermeable insulation value >65% of total
 - Class III vapor control

Note & example: For roofs, a sheathing R-value as a percentage of the total assembly R-value is specified. This is different from walls which prescribe the sheathing-to-cavity R-value ratios.

For CZs 4A, 4B, 5 Roof Outer, air-impermeable insulation value > 50% of total R-value. To achieve this, determine the total R-value of the cavity insulation + the R-value of the exterior continuous insulation. 2x10 rafters with dense-pack cellulose is approximately R-33.3 (R-3.6/in x 9.25") and the continuous insulation outboard with Polyisocyanurate is approximately R-18 (R-6/in x 3"). The calculated ratio would be R-18 / R-51.3 (total R-value) = 35.1% which would just pass the minimum of a 35% ratio noted above.

Air-impermeable insulation can be in the form of expanded polystyrene (EPS) with approximately R-4 per inch, extruded polystyrene (XPS) with R-5 per inch, polyisocyanurate (PIC) with approximately R-6 per inch, 2 pcf (32 kg/m³) closed-cell spray foam (usually around R-6 per inch) or 0.5 pcf (8 kg/m³) open cell spray foam (usually around R-4 per inch). All of these products, other than open-cell spray foam and EPS, provide a Class II vapor control layer in thicknesses of 1.5" or more. EPS and 1 pcf density (16 kg/m³) which requires between 3" and 5" (depending on density) to reach Class II performance, and open cell foam requires a special vapor control coating.

d) Unvented roof assemblies with insulation comprised of only air-impermeable and Class II vapor control insulation between, within, or outside the structure.

The EPS and urethane foam cores of wood or metal SIPS, board foams, and medium density closed cell spray foam (between wood or steel studs), if installed as continuous layers, all provide their own vapor control layers and require no additional vapor diffusion control in any climate with normal residential and commercial interior humidity conditions. Wood studs and cracks between steel or wood studs do not allow significant vapor to flow by diffusion and hence do not change the recommendations.

Cracks between framing members and panels are significant for airflow control and must be addressed in all the systems described above. A very effective airflow control layer is required on the inside of the insulation and/or framing for all unvented roof assemblies.

B-4 Moisture Control Guidelines for Floors

Floors that are subject to “bulk water events⁶⁰” (i.e. have plumbing fixtures or hot water tanks in a room above) from above have trouble drying out.

B-4.1 Floors with Air Permeable Insulation

The use of fluffy (air permeable or water absorbing) insulation in floors is preferably limited to a thin layer near the inside for sound deadening purposes.

- Floors with air permeable or water absorbing⁶¹ insulation (or acoustical material) that are at subject to bulk water events from above must meet both requirements outlined below:
 - Provide a water resisting layer above the air permeable or water absorbing insulation (or acoustical material).
 - Examples: vapor permeable weather resistive membrane or an impermeable waterproofing.
 - Limit the thickness of air permeable or water absorbing insulation (or acoustical material) to less than or equal to (\leq) 2.5” (5cm).
 - If more than ($>$) 2.5” of air permeable or water absorbing insulation (or acoustical material) is provided, the assembly must pass the hygrothermal performance test according to the protocol in the [Moist Risk Analysis & Assessment using WUFI](#) (v1.0 or later)
- Suspended floors with air permeable or water absorbing insulation (or acoustical material) that are not at risk to bulk water events from above (i.e. do not have plumbing fixtures or hot water tanks in a room above) and that are accessible from below for repair should follow the vapor control requirements for walls outlined in [Appendix B-2](#).

Advisory notes on particular situations:

One situation that will usually fail the performance test is the case of a fluffy floor directly on a slab in a cold climate, or only a thin layer of rigid on the bottom and slab or ground directly below. These might pass in hot climates, but in cold climates there is a high risk that the floor would never dry out from a bulk water event, and repair could be expensive, requiring removal of interior walls.

Another situation of concern is the case of a crawlspace in a mixed climate with humid summers. In the summer these benefit from air-impermeable insulation on the bottom, as noted in ([Lstiburek 2010](#)). But with fluffy cavity insulation, this creates a tradeoff with moisture

⁶⁰ Bulk water events include water heater failure, floods from dishwashers, clothes washers, sink/tub/toilet overflows, wet-pipe or dry-pipe sprinkler systems, but not incidental beverage spills or water lines to residential freezer ice-makers.

⁶¹ >3% water absorbing by volume as defined by ASTM D2842

accumulation on the cold side of the cavity in the winter, and with the ability to dry from an indoor wetting event, unless the air-impermeable insulation is thick enough.

For floors without air-impermeable insulation, over a crawl space or garage, or cantilevered over outdoor ambient conditions, hydrophobic insulation such as fiberglass or most preferably mineral wool, is preferable to cellulose (drain-down strategy instead of buffering.)

B-4.2 Below-Grade Floor Assemblies

Locating all the insulation below the structure (concrete slab or framed) with a Class I vapor control layer between the structure and the insulation is the practical and economical manifestation of the perfect enclosure. Some insulations provide the same level of vapor control (foil-faced polyiso or EPS, plastic-faced XPS) but many products will require a special low-permeance layer (polyethylene sheet is commonly used, inexpensive, and effective).

If no impermeable floor finishes are likely to be used during the life of the structure, the vapor control class requirement can be relaxed to a Class II. See also BSI-003: Concrete Floor Problems and BSI-009: New Light in Crawl Spaces online at buildingscience.com for more discussion of vapor control and flooring.

Appendix C – Method for Evaluating when a Cooling System is Recommended

Some designers are against the use of cooling systems, and indeed, in regard to the building code, the “cooling-is-a-luxury” perspective survived the introduction of air-conditioning. North American building codes do not require a cooling system in any climate, nor do the U.S. Energy Star requirements which are part of the Phius certification program.

The question of when to design in a cooling system could be decided with reference to ASHRAE 55. Clause 5.4 lays out the procedure for determining Acceptable Thermal Conditions in Occupant-Controlled Naturally Conditioned Spaces, based on the climate.

Reviewing the daily mean outside temperatures in the hottest part of the year, calculates a running average, and then from a graph/formulas determines the acceptable range of indoor operative temperature, which cannot be any higher than 89 F regardless of climate. The formula for the upper limit is:

$$0.31 * T_{pma-out} + 60.5 \text{ F}$$

where $T_{pma-out}$ is the “prevailing mean outdoor temperature”.

$T_{pma-out}$ must be less than 92.3 F. (There is also a lower limit which is 12.6 F cooler.)

- Up to another 4.0 F can be added to the upper limit if increased air speed of 236 fpm can be provided (with fans).

For the $T_{pma-out}$ calculation the language of ASHRAE 55 prefers TMY3 or actual daily weather data, but monthlies are allowed if those are not available. Seven to thirty days of averaging is acceptable. For example, in Dubuque, Iowa, picking in the middle at 18 days (432 hours) and running the average, $T_{pma-out}$ tops out at 73.9 F which is a little warmer than the 70.2 maximum in the monthly file.

This makes the upper operative temperature limit (Top):

$$\text{Top} = 0.31 * 70.2 + 60.5 = 82.2 \text{ F, by monthly data maximum}$$

$$\text{Top} = 0.31 * 73.9 + 60.5 = 83.4 \text{ F, by TMY3 18-day running average}$$

Going by the monthly, then with the air speed adjustment the limits are

$$\text{Top} = 82.2 + 2.2 = 84.4 \text{ F, for air speed 118 fpm}$$

$$\text{Top} = 82.2 + 3.2 = 85.4 \text{ F, for air speed 177 fpm}$$

$$\text{Top} = 82.2 + 4.0 = 86.2 \text{ F, for air speed 236 fpm}$$

It may be fair to credit the 118 fpm if there are any ceiling fans. U.S. Energy Star ratings for ceiling fans report air flow in cubic feet per minute, which can be converted to fpm directly under the fan using the fact that the test duct is a cylinder eight inches larger in diameter than

the fan. Air speed in the room could be then estimated from consideration of the room cross section compared to the fan.

Phius' protocol is outlined as follows:

1.3

A cooling system may reasonably be foregone if all of the following conditions are met:

- Representative occupants have metabolic rates ranging from 1.0 to 1.3 met.
- Representative occupants are free to adapt their clothing to the indoor and/or outdoor conditions within a range at least as wide as 0.5 to 1.0 Clo.
- The prevailing mean outdoor temperature $T_{pma-out}$ (monthly max) is greater than 50 F and less than 92.3 F.
- WUFI Passive model calculates no cooling load with a cooling set point of $0.31 * T_{pma-out} + 60.5$ F (plus 2.2 F if there are ceiling fans).
 - Input the upper-limit temperature into the building's WUFI Passive energy model as a cooling set-point.
 - Natural ventilation for day/night may be modeled, but no higher than B.A. protocol allows as outlined in section [6.7.3 Summer Ventilation](#).

The conditions on the representative occupants might always be assumed true for residential but might not be for nonresidential. However, as noted above, residential occupancies are demographically more likely to be occupied by sensitive people than workplaces, so a cooling system is more strongly advisable for residential.

Appendix D - ASHRAE Fundamentals 2017 Non-Residential Equipment Tables

Table 8A: Recommended Heat Gain for Typical Desktop Computers

Table 8B: Recommended Heat Gain for Typical Laptops and Laptop Docking Stations

Table 8C: Recommended Heat Gain for Typical Tablet PC

Table 8D: Recommended Heat Gain for Typical Monitors

Table 9: Recommended Heat Gain for Typical Printers

Table 10: Recommended Heat Gain for Miscellaneous Equipment

Table 11: Recommended Load Factors for Various Types of Offices

Table 12: Diversity Factor for Different Equipment

| Table 8A Recommended Heat Gain for Typical Desktop Computers | | |
|---|------------------------------------|-------------------------------------|
| Description | Nameplate Power, ^a W | Peak Heat Gain, ^{b,d} W |
| Manufacturer 1 | | |
| 3.0 GHz processor, 4 GB RAM, n=1 | NA | 83 |
| 3.3 GHz processor, 8 GB RAM, n=8 | NA | 50 |
| 3.5 GHz processor, 8 GB RAM, n=2 | NA | 42 |
| 3.6 GHz processor, 16 GB RAM, n=2 | NA | 66 |
| 3.3 GHz processor, 16 GB RAM, n=2 | NA | 52 |
| 4.0 GHz processor, 16 GB RAM, n=1 | NA | 83 |
| 3.3 GHz processor, 8 GB RAM, n=1 | NA | 84 |
| 3.7 GHz processor, 32 GB RAM, n=1 | 750 | 116 |
| | NA | 102 |
| 3.5 GHz processor, 16 GB RAM, n=3 ^c | 550 | 144 |
| | NA | 93 |
| Manufacturer 2 | | |
| 3.6 GHz processor, 32 GB RAM, n=8 | NA | 80 |
| 3.2 GHz processor, 16 GB RAM, n=1 | NA | 78 |
| 3.4 GHz processor, 32 GB RAM, n=1 | NA | 72 |
| 3.4 GHz processor, 24 GB RAM, n=1 | NA | 86 |
| 3.5 GHz processor, 4 GB RAM, n=1 | NA | 26 |
| 3.3 GHz processor, 8 GB RAM, n=1 | NA | 78 |
| 3.2 GHz processor, 8 GB RAM, n=1 | NA | 61 |
| 3.7 GHz processor, 4 GB RAM, n=1 | NA | 44 |
| 2.93 GHz processor, 16 GB RAM, n=1 | NA | 151 |
| 2.67 GHz processor, 8 GB RAM, n=1 | NA | 137 |
| Average 15-min peak power consumption (range) | 82 (26-151) | |
| <i>Source:</i> Bach and Sarfraz (2017) | | |
| n= number of tested equipment of same configuration. | | |
| ^a Nameplate for desktop computer is present on its power supply, which is mounted inside desktop, hence not assessible for most computers, where NA = not available. | | |
| ^b For equipment peak heat gain value, highest 15-min interval of recorded data is listed in tables. | | |
| ^c For tested equipment with same configuration, increasing power supply size does not increase average power consumption. | | |
| ^d Approximately 90% convective heat gain and 10% radiative heat gain. | | |

| Table 8B Recommended Heat Gain for Typical Laptops and Laptop Docking System | | | |
|---|---|------------------------------------|-------------------------------------|
| Equipment | Description | Nameplate Power, ^a W | Peak Heat Gain, ^{b,c} W |
| Laptop computer | Manufacturer 1, 2.6 GHz processor, 8 GB RAM, n=1 | NA | 46 |
| | Manufacturer 2, 2.4 GHz processor, 4 GB RAM, n=1 | NA | 59 |
| Average 15-min peak power consumption (range) | | 61 (26-151) | |
| Laptop with docking station | Manufacturer 1, 2.7 GHz processor, 8 GB RAM, n=1 | NA | 38 |
| | 1.6 GHz processor, 8 GB RAM, n=2 | NA | 45 |
| | 2 GHz processor, 8 GB RAM, n=1 | NA | 50 |
| | 2.6 GHz processor, 4 GB RAM, n=1 | NA | 51 |
| | 2.4 GHz processor, 8 GB RAM, n=1 | NA | 40 |
| | 2.6 GHz processor, 8 GB RAM, n=1 | NA | 35 |
| | 2.7 GHz processor, 8 GB RAM, n=1 | NA | 59 |
| | 3.0 GHz processor, 8 GB RAM, n=3 | NA | 70 |
| | 2.9 GHz processor, 32 GB RAM, n=3 | NA | 58 |
| | 3.0 GHz processor, 32 GB RAM, n=1 | NA | 128 |
| 3.7 GHz processor, 32 GB RAM, n=1 | NA | 63 | |
| 3.1 GHz processor, 32 GB RAM, n=1 | NA | 89 | |
| Average 15-min peak power consumption (range) | | 61 (26-151) | |
| <i>Source:</i> Bach and Sarfraz (2017) | | | |
| n= number of tested equipment of same configuration. | | | |
| ^a Voltage and amperage information for laptop computer and laptop docking station is available on power supply nameplates; however, nameplate does not provide information on power consumption, where NA = not available. | | | |
| ^b For equipment peak heat gain value, highest 15-min interval of recorded data is listed in tables. | | | |
| ^c Approximately 75% convective heat gain and 25% radiative heat gain. | | | |

| Description | Nameplate Power, ^a W | Peak Heat Gain, ^b W |
|---|---------------------------------|--------------------------------|
| 1.7 GHz processor, 4 GB RAM, n=1 | NA | 42 |
| 2.2 GHz processor, 16 GB RAM, n=1 | NA | 40 |
| 2.3 GHz processor, 8 GB RAM, n=1 | NA | 30 |
| 2.5 GHz processor, 8 GB RAM, n=1 | NA | 31 |
| Average 15-min peak power consumption (range) | 36 (31-42) | |
| <i>Source:</i> Bach and Sarfraz (2017) n= number of tested equipment of same configuration ^a Voltage and amperage information for tablet PC is available on power supply nameplates; however, nameplate does not provide information on power consumption, where NA = not available. ^b For equipment peak heat gain value, highest 15-min interval of recorded data is listed in tables. | | |

| Equipment | Description | Max. Printing Speed, Pages per Minute | Nameplate Power, W | Peak Heat Gain, ^a W |
|--|-------------------------------|---------------------------------------|--------------------|--------------------------------|
| Multifunction printer (copy, print, scan) | Large, multiuser, office type | 40 | 1010 | 540 (Idle 29 W) |
| | | 30 | 1300 | 303 (Idle 116 W) |
| | | 28 | 1500 | 433 (Idle 28 W) |
| Average 15-min peak power consumption | | | 425 (303-540) | |
| Monochrome printer | Desktop, medium-office type | 35 | 900 | 732 (Idle 18 W) |
| | | 25 | 470 | 56 (Idle 3 W) |
| | | 55 | 1000 | 222 |
| Average 15-min peak power consumption | | | 142 (61-222) | |
| Color printer | Desktop, medium-office type | 40 | 620 | 120 |
| Laser printer | Desktop, small-office type | 14 | 310 | 89 |
| | | 24 | 495 | 67 |
| | | 26 | 1090 | 65 |
| Average 15-min peak power consumption | | | 74 (65-89) | |
| Plotter | Manufacturer 1 | | 1600 | 571 |
| | Manufacturer 2 | | 270 | 173 |
| Average 15-min peak power consumption | | | 372 (173-571) | |
| Fax machine | Medium | | 1090 | 92 |
| | Small | | 600 | 46 |
| Average 15-min peak power consumption | | | 69 (46-92) | |
| <i>Source:</i> Bach and Sarfraz (2017) ^a Approximately 70% convective heat gain and 30% radiative heat gain. | | | | |

| Description ^a | Nameplate Power, W | Peak Heat Gain, ^{b,c} W |
|---|--------------------|----------------------------------|
| Manufacturer 1 | | |
| 1397 mm LED flat screen, n=1 (excluded from average because atypical size) | 240 | 50 |
| 686 mm LED flat screen, n=2 | 40 | 26 |
| 546 mm LED flat screen, n=2 | 29 | 25 |
| Manufacturer 2 | | |
| 1270 mm 3D LED flat screen, n=1 (excluded from average because atypical size) | 94 | 49 |
| Manufacturer 3 | | |
| 864 mm LCD curved screen, n=1 (excluded from average because atypical size and curved) | 130 | 48 |
| 584 mm LED flat screen, n=3 | 50 | 17 |
| 584 mm LED flat screen, n=1 | 38 | 21 |
| 584 mm LED flat screen, n=1 | 38 | 14 |
| Manufacturer 4 | | |
| 610 mm LED flat screen, n=1 | 42 | 25 |
| Manufacturer 5 | | |
| 600 mm LED flat screen, n=1 | 26 | 17 |
| 546 mm LED flat screen, n=1 | 29 | 22 |
| Manufacturer 6 | | |
| 546 mm LED flat screen, n=1 | 28 | 24 |
| Average 15-min peak power consumption (range) | | 21 (14-26) |
| <i>Source:</i> Bach and Sarfraz (2017) n= number of tested equipment of same configuration. ^a Screens with atypical size and shape are excluded for calculating average 15-min peak power consumption. ^b For equipment peak heat gain value, highest 15-min interval of recorded data is listed in tables. ^c Approximately 60% convective heat gain and 40% radiative heat gain. | | |

| Equipment | Diversity Factor, % | Diversity Factor, ^a % |
|---|---------------------|----------------------------------|
| Desktop PC | 75 | 75 |
| Laptop docking station | 70 | NA |
| Notebook computer | 75 ^b | 75 |
| Screen | 70 | 60 |
| Printer | 45 | NA |
| <i>Source:</i> Bach and Sarfraz (2017) ^a 2013 ASHRAE Handbook-Fundamentals ^b Insufficient data from RP-1742; values based on previous data from 2013 ASHRAE Handbook-Fundamentals and judgement of Bach and Sarfraz (2017). | | |

| Equipment | Nameplate Power, ^a W | Peak Heat Gain, ^b W |
|--|---------------------------------|--------------------------------|
| Vending machine | | |
| Drinks, 280 to 400 items | NA | 940 |
| Snacks | NA | 54 |
| Food (e.g., for sandwiches) | NA | 465 |
| Thermal building machine, 2 single documents up to 340 pages | 350 | 28.5 |
| Projector, resolution 1024 x 768 | 340 | 308 |
| Paper shredder, up to 28 sheets | 1415 | 265 |
| Electric stapler, up to 45 sheets | NA | 1.5 |
| Speakers | 220 | 15 |
| Temperature-controlled electronics soldering station | 95 | 16 |
| Cell phone station | NA | 5 |
| Battery charger | | |
| 40 V | NA | 19 |
| AA | NA | 5.5 |
| Microwave oven, 7 to 9 gal | 1000 to 1550 | 713 to 822 |
| Coffee maker | | |
| Single cup | 1400 | 385 |
| Up to 12 cups | 950 | 780 |
| With grinder | 1350 | 376 |
| Coffee grinder, up to 12 cups | NA | 73 |
| Tea kettle, up to 6 cups | 1200 | 1200 |
| Dorm fridge, 3.1 ft ³ | NA | 57 |
| Freezer, 18 ft ³ | 130 | 125 |
| Fridge, 18 to 28 ft ³ | NA | 387 to 430 |
| Ice maker and dispenser, 20 lb. bin capacity | NA | 658 |
| Top mounted bottled water cooler | NA | 114 to 350 |
| Cash register | 25 | 9 |
| Touch screen computer, 15 in. standard LCD and 2.2 GHz processor | NA | 58 |
| Self-checkout machine | NA | 15 |
| <i>Source:</i> Bach and Sarfraz (2017) | | |
| ^a For some equipment, nameplate power consumption is not available, where NA= not available. | | |
| ^b For equipment peak heat gain value, highest 15-min interval of recorded data is listed in tables. | | |

| Type of Use | Load Factor*, W/ft ² | Description |
|--|---------------------------------|---|
| 100% laptop, docking station | | |
| light | 0.34 | 167 ft ² /workstation, all laptop docking station use, 1 printer per 10 |
| medium | 0.46 | 125 ft ² /workstation, all laptop docking station use, 1 printer per 10 |
| 50% laptop, docking station | | |
| light | 0.44 | 167 ft ² /workstation, 50% laptop docking station use/50% desktop, 1 printer per 10 |
| medium | 0.59 | 125 ft ² /workstation, 50% laptop docking station use/50% desktop, 1 printer per 10 |
| 100% desktop | | |
| light | 0.54 | 167 ft ² /workstation, all desktop use, 1 printer per 10 |
| medium | 0.72 | 125 ft ² /workstation, all desktop use, 1 printer per 10 |
| 100% laptop, docking station | | |
| 2 screens | 0.69 | 125 ft ² /workstation, all laptop docking station use, 2 screens, 1 printer per 10 |
| 100% desktop | | |
| 2 screens | 0.84 | 125 ft ² /workstation, all desktop use, 2 screens, 1 printer per 10 |
| 3 screens | 0.96 | 125 ft ² /workstation, all desktop use, 3 screens, 1 printer per 10 |
| 100% desktop | | |
| heavy, 2 screens | 1.02 | 85 ft ² /workstation, all desktop use, 2 screens, 1 printer per 8 |
| heavy, 3 screens | 1.16 | 85 ft ² /workstation, all desktop use, 3 screens, 1 printer per 8 |
| 100% laptop, docking station | | |
| full on, 2 screens | 1.14 | 85 ft ² /workstation, all laptop docking use, 2 screens, 1 printer per 8, no diversity |
| 100% desktop | | |
| full on, 2 screens | 1.33 | 85 ft ² /workstation, all desktop use, 2 screens, 1 printer per 8, no diversity |
| full on, 3 screens | 1.53 | 85 ft ² /workstation, all desktop use, 3 screens, 1 printer per 8, no diversity |
| <i>Source:</i> Bach and Sarfraz (2017) | | |
| *Medium-office type monochrome printer is used for load factor calculator with 15-min peak power consumption of 142 W. | | |

Appendix E – Phius Certified Rater/Verifier Manual: Version 1.2

This section outlines the prerequisites and process of becoming a Phius Certified Rater or Phius Certified Verifier, eligibility to inspect and verify Phius projects, and the responsibilities of the Rater/Verifier in the certification of Phius projects.

E-1.0 Definition & Eligibility

Phius Certified Raters and Phius Certified Verifiers are certified professionals eligible to perform the on-site inspections and performance testing requirements for verification of all aspects of Phius Certification. The eligibility of each professional to inspect and verify a given project type depends on the designation.

E-1.1 Phius Certified Rater

Eligible to inspect and verify single-family homes, duplexes and Townhomes (as defined under Energy Star Certified Homes Program) for Phius certification.

E-1.2 Phius Certified Verifier

All Phius Certified Verifiers are eligible to inspect and verify non-residential projects for Phius certification.

E-1.2.1 Multifamily Designation

Phius Certified Verifiers with the multifamily designation are also eligible to inspect and verify multifamily projects (including townhomes) for Phius certification. See more on Exam Eligibility.

E-1.3 Third Party Status

Phius Certified Rater and Phius Certified Verifiers cannot serve as the CPHC or builder on a project in which they are performing verification. However, another member of the Rater/Verifier's company may perform this scope with prior written approval from Phius certification staff.

E-2.0 Certification Requirements and Maintenance

E-2.1 Phius Certified Rater Information

The Phius Certified Rater training course is geared toward single-family building professionals. The course will be open to any potential candidates. Certification and earning the professional title of Phius Certified Rater will be contingent upon applying for and passing the Phius Certified Rater Exam.

E-2.1.1 Phius Certified Rater Exam Eligibility

To be eligible to take the Phius Certified Rater Exam the following documentation must be provided when applying for the exam:

In the United States:

1. Provide proof of all the following:
 - a. Current EPA Energy Star Rater Partnership Agreement
 - b. Current EPA Indoor airPLUS Partnership Agreement
 - c. Current Dept. of Energy (DOE) Zero Energy Ready Homes Rater Partnership
 - d. Successful completion of EPA Energy Star Certified Homes v3.1 Training
 - e. Successful completion of Phius Certified Rater Training, OR already Certified as a Phius Certified Verifier
 - f. Alignment with recognized programs per below:
 1. All states except California and Alaska:
 - Fully Certified as a RESNET HERS Rater
 - Currently aligned with a RESNET QA Provider and in good standing with RESNET
 2. In California
 - Be certified as a HERS Rater and be in good standing with either a RESNET QA Provider or a California Energy Commission Approved-Provider
 3. In Alaska
 - Be certified as a HERS Rater and be in good standing with either a RESNET QA Provider or a certified Energy Rater through the Alaska Housing Finance Corporation.

In Canada:

1. Be a certified rater in good standing with either CRESNET or Natural Resources Canada.
2. Attest to knowledge and understanding of the EPA ENERGY STAR Certified Homes, EPA Indoor airPLUS Certified Homes, and a DOE Zero Energy Ready Homes programs.

In other international locations:

1. Credentials will be verified on a case-by-case basis. Candidates should have a background in residential energy inspections and testing.
2. Attest to knowledge and understanding of the EPA ENERGY STAR Certified Homes, EPA Indoor airPLUS Certified Homes, and a DOE Zero Energy Ready Homes programs.

E-2.1.2 Phius Certified Rater Certification

To become a Phius Certified Rater and serve as a Phius Certified Rater on a project, one must:

- a. Pass the Phius Certified Rater Exam
- b. Sign the Phius Certified Rater Agreement
- c. Remain an active Phius Certified Rater.

For projects where no Phius Certified Verifier is within 200 miles of project, but a Phius Certified Rater is within 200 miles of the project, a Phius Certified Rater may serve as the Phius Certified Verifier on the project so long as they are approved by Phius for the project in question.

E-2.1.3 Phius Certified Rater Renewal

Phius Certified Rater credentials expire 3 years after their original certification date. To extend the credential another 3 years, a Rater must:

Complete **1 of 3** items below:

1. Obtain 12 Phius CEUs before their expiration date.
 - CEUs can be earned from any Phius-hosted, Phius Alliance-hosted, or Phius CEU-approved event.
2. Complete a Phius Certified project as the Phius Certified Rater.
3. Take and Pass the Phius Certified Rater Re-Certification Exam.

To maintain their database listing, each year, a Phius Certified Rater must also:

- Log into the Phius Portal, review their RESNET Status and Provider information, update as needed, and certify that the information is accurate. (Exception: CA and AK Raters must confirm status with their state sponsored ratings systems and providers)

E-2.1.4 Phius Certified Rater Expiration

Phius Certified Rater credentials expire every three years. A Rater who fails to meet the requirements outlined in E-2.1.3 above will be removed from the professional's database.

E-2.1.5 Phius Certified Rater Re-Activation

A professional whose Rater status has expired can reactivate certification by applying for and passing Phius Certified Rater Re-Certification Exam.

E-2.2 Phius Certified Verifier Information

The Phius Certified Verifier training course is geared toward non-residential and multifamily building professionals. The course will be open to any potential candidates. Actual certification and earning the professional title of Phius Certified Verifier will be contingent upon applying for and passing the Phius Certified Verifier Exam.

As a baseline, earning the Phius Certified Verifier designation will qualify the professional to verify non-residential buildings. To become qualified to verify multifamily buildings, additional prerequisites must be met. Phius will review these prerequisites in the application submitted by the candidate for the exam to earn the multifamily designation. There will be an identifier for professionals with the Multifamily designation in the professional's database.

E-2.2.1 Phius Certified Verifier Exam Eligibility

The Phius Certified Verifier exam has two options: Baseline and Baseline + Multifamily Designation. The Baseline must be taken by all wishing to achieve certification. Those wishing to qualify for multifamily projects must take and pass the additional multifamily exam.

The following documentation must be provided when applying for the exam:

Prerequisite to take Phius Certified Verifier Exam (baseline):

- a. Completion of Phius Certified Verifier Course
- b. Proof of verification and/or commissioning experience for commercial, non-residential, or multifamily buildings

Prerequisite to add the Multifamily Designation:

- c. Compliance with Path A or Path B below:
 - **Path A:** Proof of all prerequisites for Phius Certified Rater (Outlined in Section E-2.1.1)
 - **Path B:** Proof of RESNET Field Inspector status
- d. Proof of completion of Energy Star Multifamily New Construction V 1/1.1 Rater Training Course
- e. Proof of completion of RESNET Multifamily High Rise Training Modules

E-2.2.2 Phius Certified Verifier Certification

To become a Phius Certified Verifier and serve as a Phius Certified Verifier on a non-residential project, one must:

- a. Pass the Phius Certified Verifier Exam
- b. Sign the Phius Certified Verifier Agreement
- c. Remain an active Phius Certified Verifier

To become certified as a Phius Certified Verifier and serve as a Phius Certified Verifier on a multifamily project, one must:

- a. Pass the Phius Certified Verifier Exam
- b. Pass the Phius Certified Verifier Multifamily Designation Exam
- c. Sign the Phius Certified Verifier Agreement

- d. Remain an active Phius Certified Verifier

If a Phius Certified Verifier without the multifamily designation wishes to verify multifamily projects, they can apply to take the Phius Certified Verifier Multifamily Designation Exam at any time and must meet all prerequisites for that as outlined above.

E-2.2.3 Phius Certified Verifier Renewal

Phius Certified Verifier credentials expire 3 years after their original certification date. To extend the credential another 3 years, a Verifier must:

Complete **1 of 3** items below:

1. Obtain 12 Phius CEUs before their expiration date.
 - CEUs can be earned from any Phius-hosted, Phius Alliance-hosted, or Phius CEU-approved event.
2. Complete a Phius Certified project as the Phius Certified Verifier.
3. Take and Pass the Phius Certified Verifier Re-Certification Exam.

On top of this, each year Verifiers with the Multifamily Designation who wish to keep this designation in their database listing must:

- Log into the Phius Portal, review their RESNET Status and Provider information, update as needed, and certify that the information is accurate. *(Exception: CA and AK Raters must confirm status with their state sponsored ratings systems and providers)*

E-2.2.4 Phius Certified Verifier Expiration

Phius Certified Verifier credentials expire every three years. A Verifier who fails to meet the requirements outlined in E-2.2.3 above will be removed from the professional's database.

E-2.2.5 Phius Certified Verifier Re-Activation

A professional whose Verifier status has expired can reactivate certification by applying for and passing the Verifier Recertification exam (baseline or baseline + multifamily designation).

E-2.3 Non-Certified Inspectors

Where no Phius certified professional is within 200 miles of a project, a project may elect to use a non-Phius certified professional to perform site inspections and testing if approved by Phius Staff.

Requirements are outlined below:

1. Non-certified inspectors shall meet the eligibility requirements for either Phius Certified Rater or Verifier, other than having attended the training.
2. Non-certified inspectors shall contract with and work directly under the supervision of an existing certified Phius Certified Rater or Verifier.
 - a. This relationship shall require at a minimum that the Phius Certified certified professional conducts virtual training on the Phius Workbook and testing standards, and reviews all documentation issued by the Phius Certified Verifier/Rater detailing their inspection and testing protocol.
 - b. The Phius certified professional shall complete a letter of attestation to this training/mentorship. Letter of Attestation can be downloaded [here](#).

Alternatively, where a Phius Certified Rater or Verifier has other verification staff who are otherwise qualified but are not yet Phius certified professionals, they may be permitted to perform verification so long as:

1. The Phius Certified Rater/Verifier takes full responsibility for their verification work.
2. The Phius Certified Rater/Verifier completes a letter of attestation of training/mentorship on Phius-specific verification scopes of work.
3. The candidate otherwise meets all the other eligibility criteria. At a minimum, the not yet Phius certified professionals should at least be certified as RESNET HERS Rater.

E-3.0 Pre-Construction Requirements

E-3.1 Contracting with a Project

A project team attempting Phius certification for a project will contract with a Phius Certified Rater or Verifier prior to construction, and ideally while the project is in design phase. Phius recommends the project team will contract with a Phius Certified Rater or Verifier as early in the design process as possible.

Contracts can be entered into between the Rater/Verifier and any member of the project team. Preferably, but not a requirement, the contract will be with the project owner so that the Rater/Verifier can remain fully independent of the construction and design teams.

Phius Certified Rater/Verifiers cannot serve as the Phius Certified Consultant (CPHC) or builder on a project in which they are performing verification. However, another member of the Rater/Verifier's company may perform the scope of work of the CPHC with prior written approval from Phius certification staff.

E-3.2 Project Team Training

While it is ultimately the responsibility of the project team to ensure a project is fully compliant with Phius certification requirements, it is the Rater/Verifier's responsibility to ensure that all critical project team members understand the Phius Certification process, program requirements, and individual requirements from partner programs such as the EPA ENERGY STAR Certified Homes, EPA ENERGY STAR Multifamily New Construction Program, EPA Indoor airPLUS and DOE Zero Energy Ready Homes programs.

It is not the responsibility of the Rater/Verifier to train builders, building subcontractors, designers, or any other project team member on specific scopes of work to construct Phius compliant projects, other than to make them aware of the requirements listed in the Phius Workbook or allied documents. The Rater/Verifier may choose to provide such guidance at their own discretion.

E-3.3 Design Review

It is encouraged that the Phius Certified Rater/Verifier be present at design review meetings with the project team where possible.

While it is not the responsibility that the Rater/Verifier provide guidance or feedback on the design, it may be helpful where the Rater/Verifier has valuable experience to offer project team members.

- Any guidance on design/implementation strategies shall be given at their own discretion.
- It is encouraged that Phius Certified Rater/Verifiers carry a minimum of \$500,000 professional liability insurance if giving specific design or construction guidance.

E-4.0 Technical Inspection and Field Requirements

E-4.1 Mid-Construction Inspections

A minimum of two mid-construction inspections shall be required; one at foundation phase to verify foundation insulation systems, and another pre-drywall. Photo documentation is required.

- RESNET Standards and program requirements for Energy Star Certified Homes and Energy Star Multifamily New Construction Program requires a minimum number of inspections to verify projects. Please ensure the work scope for services includes the minimum number of required inspection visits.

- More frequent inspections and testing may be required or requested by the project team depending on project scope, and if agreed upon by Rater/Verifier.
1. **Foundation Inspection** - the following shall be observed at this phase:
 - a. Slab (both edge and under) and foundation wall insulation materials and thicknesses and R-values
 - b. Radon mitigation system piping (where applicable)
 - c. Foundation drainage systems (where applicable)
 - d. Presence of any known or unintended thermal bridges and associated mitigation strategies
 - e. General site slope/grading
 2. **Pre-drywall Inspection** - the following shall be observed at this phase:
 - a. Foundation and above grade wall cavity insulation and R-values (where applicable)
 - b. Foundation and above grade wall continuous insulation and R-values
 - c. Air sealing/air barrier details
 - d. Insulation inspections to verify material type, R-value and installation grade. If insulation material is not marked such as with blown in or spray applied materials, ESR reports shall be collected and used to validate the installed R-value. Insulation Grading and evaluation shall be in compliance with ANSI/RESNET/ICC Standard 301-2019 Appendix A "Insulation Grading"
 - e. Presence of any known or unintended thermal bridges and associated mitigation strategies
 - f. Window specification, NFRC data or equivalent data, rough opening sizes, location, overhangs, shading and install condition. Verification of window performance shall be collected and can consist of published NFRC data, photos of NFRC labels, Shop Drawings, Manufacturer's Data, or other evidence of the installed window(s).
 - g. Mid-construction air tightness test (optional). Note Phius CORE 2021 Prescriptive path for SF homes REQUIRES a mid-construction air tightness test. Refer to Section 3: Building Certification Requirements for more details.

E-4.2 Final Inspection and Testing

Once final construction is substantially complete, the Phius Certified Rater/Verifier shall perform the following measures.

E-4.2.1 Verification

The following shall be verified at final:

- a. Ceiling R-values and any other insulation not previously verified
- b. Distance and R-value of ventilation ducts to exterior
- c. Window overhang, external and adjacent shading attributes
- d. Final site grading
- e. Radon mitigation system final installation (where applicable)
- f. Mechanical system make/models
- g. Appliance make/models
- h. Lighting efficiency percentages
- i. Major process loads or other electrical loads (where applicable)
- j. On-site renewable energy systems
- k. Infrared Inspection of interior and exterior of building
- l. All other mandatory ENERGY STAR, Indoor airPLUS, Zero Energy Ready Home or Phius requirements.

E-4.2.2 Testing

All testing required per the applicable Phius Workbook shall be used, including:

E-4.2.2.1 Whole-building airtightness

- a. Conducted in both pressurization and depressurization modes
- b. Using multipoint testing that meets either the provisions of:
 1. ANSI/RESNET/ICC 380-2019, or The Air Barrier Association of America Standard Method for Building Enclosure Airtightness Compliance Testing
 2. Measured Infiltration air flow test results shall indicate a standard level of accuracy test result or have an accuracy within 10%.
 3. The Test Reports shall indicate a Correlation Coefficient of 0.95 or greater.

E-4.2.2.2 Duct leakage testing (where applicable)

- a. Only required for dwelling unit heating and cooling ducts >10' total system length. It is encouraged that duct testing be conducted at rough-in stage before concealment.
Note: RESNET MINHERS Standards require duct Leakage to Outside to be measured.
- b. Testing to be conducted in accordance with ANSI/RESNET/ICC 380-2019
- c. For ventilation systems, common space systems, and non-residential systems, duct testing may be required by the Energy Star Multifamily New Construction Program. Phius recommends this as a valuable diagnostic tool to ensure proper airflow and balancing can be achieved.

E-4.2.2.3 Ventilation system testing

- a. Room-by-room balancing
 1. Testing can be performed using devices such as the Retrotec Flow Finder, Energy Conservatory Flowblaster, Energy Conservatory Exhaust Fan Flow Meter (for flows under 35 CFM), Testo 417 (for flows under 100 CFM) with flow straightener and capture hood, CFM-range appropriate non-powered flow hood, and duct tester device with custom capture hood attachment.
 - i. Any other device or methodology must be preapproved by Phius and listed in ANSI/RESENT/ICC Standard 380-2019.
 2. Alternatively, a certified third-party air balancer or product commissioning agent can provide a detailed air balancing report in lieu of the Rater performing this task. A minimum number of air flows are to be verified by the Rater or Verifier per the QA Workbook requirements.
 - i. For MF verification of 3rd party air-balancer work, see the most current version of the Energy Star Multifamily New Construction Program documents.
- b. Total ventilation system airflow at unit (supply & exhaust) at maximum speed setting/capacity.
 1. Used to determine if recommended 0.3 ACH can be achieved.
- c. Total ventilation system airflow at unit (supply & exhaust) at typical operation
 1. Total supply and exhaust shall be at least 100% of the design values and within 10% of each other.
 2. Individual room supply and exhaust airflows shall be at least 100% of the design values and no more than 20% or 5cfm greater than design values (whichever is larger).
 - i. Note minimum exhaust airflows are mandated per Ventilation requirements outlined in Section 3 of the Guidebook.
 3. Alternatively, measurements of the outdoor air inlet and exhaust outlet of the ventilation system can be made on the exterior of a building using a pressure matching tool such as a duct tester or powered flow hood, so long as:
 - i. Measurements can be made safely
 - ii. The ducts connecting the system to outside are well sealed
 - iii. Environmental conditions (wind) will not adulterate the test results.
 - iv. Ventilation in/outlets are possible to test without building products or architectural features interfering.
- d. Power consumption measurement recorded in watts for ventilation units in typical 24/7 mode using of the following methods:

1. Using a power-factor adjusted wattage clamp meter, such as the Amprobe NAV-51, tested at the electrical panel or other accessible location
2. Using a plug-in watt meter such as the Kill-a-Watt, so long as the system has an electrical plug
3. Using measured total system airflow or external static pressure and a manufacturer's fan curve table
4. Alternatively, this may be tested by a third-party balancing firm, HVAC contractor or electrician.

E-4.2.2.4 Heating and cooling system airflow testing

- a. Room-by-room balancing, see ventilation provisions above
- b. Total system airflow, see ventilation provisions above

E-4.2.2.5 Bedroom pressure balancing

- a. Ducted heating and cooling systems
 - For multifamily buildings, Bedrooms with greater than 150 cfm shall be pressure balanced to +/- 5 Pa with respect to the main body of the dwelling unit with all other bedroom doors closed and all air handlers running.
 - For Townhouses only, bedrooms with a design supply airflow of less than 150 cfm, the pressure differential shall be +/- 3 Pa.
 - For single-family home buildings, the Bedrooms pressure differential shall be +/- 3 Pa with respect to the main body of the house with all other bedroom doors closed and the system running.
- b. Ventilation systems
 - Bedrooms shall be pressure balanced to +/- 1 Pa with respect to the main body of the house with all other bedroom doors closed and the ventilation system running.

E-4.2.2.6 Hot water distribution system testing

Hot Water Temperature Rise Test shall be conducted for all single family projects and at a minimum sampled for dwelling units in all multifamily projects per the DOE ZERH Mandatory Requirements for Water Efficiency. Per the **Advisories** under endnote 15 of the [DOE ZERH \(Rev. 08\)](#) document:

- On-demand central systems in multifamily projects do not currently have a stored volume limit. It is encouraged, but not required, to design central hot water distribution systems in multifamily buildings to limit the stored volume between the recirculation loop and the furthest fixture to 1.0 gallons.

For multifamily buildings of all sizes with centralized recirculation systems, as per section 3.5 in the Multifamily Quality Assurance Workbook, the hot water temperature rise test is still required even though there is no requirement on the result.

DOE ZERH Water Efficiency Requirements has 2 compliance options with exceptions included in endnote 16 of the [DOE ZERH \(Rev. 08\)](#) document, here referred to as 'Alternative Compliance Option':

1. Measuring the temperature of the hot water stream, no more than 0.6 gallons (or 1.4 gallons under the Alternative Compliance Option) shall be emitted before the hot water temperature increases by 10 degrees F.
 - a. Without priming the hot water pipes (i.e., do not turn on the hot water tap for a minimum of 2 hours ahead of time), measure the temperature of the hot water stream at the hot water fixture that contains the highest volumetric water content from the water heater. This is often, but not always, the longest hot water plumbing run from the water heater.
 - b. Hot water shall be captured using a bucket, pitcher, or plastic bag with 0.6 gallons (1.4 gallons for Alternative Compliance Option) marked.
 - c. It is recommended to use either an infrared camera or a digital thermometer to check the temperature rise of the water.
2. The DOE ZERH Water Efficiency Alternative Compliance Option, wherein the Rater or Verifier shall confirm and provide documentation that the water heater and fixtures meet the criteria listed.

E-4.3 Documentation

All inspections and testing shall be documented using the most current version of the Phius Workbook that was available when the project was initially registered with Phius (based on contract date, see 'Program Version Dates' section above).

Additional documentation that shall be provided include:

1. Multi-point automated testing software reports or digital files
2. Ventilation and heating/cooling balancing reports (if not in Workbook)
3. HERS energy modeling software files or Building Summary/Building File Report pdfs.

Exceptions - not required for:

- a) CA, AK, or international projects
 - b) Multifamily projects certified to Energy Star MFNC under the Prescriptive or ASHRAE/Alternative Phius Path
 - c) Non-Residential Projects
4. Clearly labeled photos, including a minimum of:

- a) Foundation insulation
 - b) Air sealing details
 - c) Above-grade insulated assemblies
 - d) Known thermal-bridges and/or mitigation strategies
 - e) Surrounding site and window shading systems
 - f) Representative thermal images demonstrating no unexpected thermal bypasses
 - g) Appliance tags clearly showing model and serial number
 - h) All HVAC equipment nameplates clearly showing model and serial numbers;
 - i. Ventilation equipment
 - ii. Hot water heater
 - iii. Air handlers and coils
 - iv. Ductless heads
 - v. Condensers
 - i) All other mechanical equipment such as for central systems and process equipment
5. Indoor airPLUS low-emitting products documentation
- i. While it is not necessarily the responsibility of the Rater/Verifier to verify compliance with all the IAP low emitting products requirements, it is necessary for the builder to provide documentation and attestation that all products are compliant.
 - ii. It is recommended that the Rater/Verifier work with the builder to develop a list of affected products, and to educate them on verifying compliance with these program requirements.

E-5.0 Post-Construction Requirements

All projects shall be documented as described above. This documentation shall be communicated to the project team so that any appropriate adjustments can be made to the Phius energy model.

- a. For Single family and multi-family projects that include a formal HERS Rating, it is recommended that specific building characteristics be reviewed and coordinated with the Phius Certified Consultant (CPHC).
 - a. Overall iCFA
 - b. Building Envelope area
 - c. Window areas & NFRC performance data

- b. After communicating documentation to the project team and final updates made to the Phius energy model, either the Rater/verifier or a member of the project team shall notify Phius certification staff that the project is ready for final review.
- c. Documentation shall be submitted to the shared Dropbox folder established by Phius for the project. Phius may request additional documentation where necessary.
- d. Phius certification staff shall review final documentation of the project and compare it to the WUFI Passive energy model and intended project specifications.
 1. Where questions arise, or changes are necessary to be made for consistency, Phius certification staff shall communicate this information to the Rater/Verifier, and or the project team where applicable to make updates.
 2. The Rater/Verifier shall use this information to make any necessary adjustments and shall resubmit all project documentation to Phius certification staff for final approval.

E-6.0 Resources

Download the latest documents from the [Resource Library](#):

1. Phius Multifamily Quality Assurance Workbook
2. Phius Single Family Quality Assurance Workbook
3. Phius Non-Residential Quality Assurance Workbook
4. Phius Certified Rater/Verifier Mentorship Letter of Attestation

Appendix F –Procedure to Prepare the Building for Airtightness Testing

F-1 ANSI/RESNET/ICC 380-2016

Standard for Testing Airtightness of Building Enclosures, Airtightness of Heating and Cooling Air Distribution Systems, and Airflow of Mechanical Ventilation Systems

3.2.1. Fenestration. Exterior doors and windows shall be closed and latched.

3.2.2. Attached garages. All exterior garage doors and windows shall be closed and latched unless the blower door is installed between the house and the garage, in which case the garage shall be opened to outside by opening at least one exterior garage door.

3.2.3. Crawlspace. If a crawlspace is unvented, interior access doors and hatches between the house and the crawl space shall be opened and exterior crawl space access doors, vents, and hatches shall be closed. If a crawl space is vented the interior access doors and hatches shall be closed and crawl space vents shall be left in their as-found position and their position shall be recorded on the test report.

3.2.4. Attics. Attic access doors and hatches shall be closed unless the attic is air sealed and insulated at the roof deck, in which case the access doors and hatches shall be opened. The position of the attic access doors and hatches shall be recorded. Exterior access doors, dampers, or vents shall be left in their as-found position and their position shall be recorded on the test report.

3.2.5. Basements. All doors between basements and Conditioned Space Volume shall be opened unless the house floor above the basement is air sealed and insulated, in which case the door between the basement and Conditioned Space Volume shall be closed. The position of the basement doors shall be recorded. Where the door to the basement is required to be closed, the basement shall be excluded from Infiltration Volume and Conditioned Floor Area.

3.2.6. Interior doors. All doors between rooms inside the Conditioned Space Volume shall be opened.

3.2.7. Chimney dampers and combustion-air inlets on solid fuel appliances. Chimney dampers and combustion-air inlets on solid fuel appliances shall be closed. Precautions shall be taken to prevent ashes or soot from entering the house during testing.

3.2.8. Combustion appliance flue gas vents. Combustion appliance flue gas vents shall be left in their as-found position.

3.2.9. Fans. Any fan or appliance capable of inducing airflow across the building enclosure shall be turned off including, but not limited to, clothes dryers, attic fans, kitchen and bathroom

exhaust fans, air handlers, ventilation fans used in a whole-house mechanical ventilation system¹, and crawlspace and attic ventilation fans. This requirement to turn fans off includes accessible fans in adjacent attached dwelling units.

3.2.10. Dampers

3.2.10.1. Non-motorized dampers that connect the Conditioned Space Volume to the exterior or to Unconditioned Space Volumes shall be left in their as-found positions.

3.2.10.2. Motorized dampers that connect the conditioned space volume to the exterior or to unconditioned spaces shall be placed in their closed positions and shall not be further sealed.

3.2.11. Non-dampered openings for ventilation, combustion air and make-up air

3.2.11.1. Non-dampered ventilation openings of intermittently operating local exhaust ventilation systems that connect the Conditioned Space Volume to the exterior or to Unconditioned Space Volume shall be left open.

3.2.11.2. Non-dampered ventilation openings of intermittently operating whole-house ventilation systems, including HVAC fan-integrated outdoor air inlets, that connect the Conditioned Space Volume to the exterior or to Unconditioned Space Volume shall not be sealed.

3.2.11.3. Non-dampered ventilation openings of continuously operating local exhaust ventilation systems that connect the Conditioned Space Volume to the exterior or to Unconditioned Space Volume shall be sealed at the exterior of the enclosure where conditions allow.

3.2.11.4. Non-dampered ventilation openings of continuously operating whole-house ventilation systems that connect the Conditioned Space Volume to the exterior or to Unconditioned Space Volume shall be sealed at the exterior of the enclosure where conditions allow.

3.2.11.5. All other Non-dampered intentional openings between Conditioned Space Volume and the exterior or Unconditioned Space Volume shall be left open.

3.2.12. Whole-building fan louvers/shutters. Whole-building fan louvers and shutters shall be closed. In addition, if there is a seasonal cover present, it shall be installed.

3.2.13. Evaporative coolers. The opening to the exterior of evaporative coolers shall be placed in its off position. In addition, if there is a seasonal cover present, it shall be installed.

3.2.14. Operable window trickle-vents and through-the-wall vents. Operable window trickle-vents and through-the-wall vents shall be closed.

3.2.15. Supply registers and return grilles. Supply registers and return grilles shall be left in their as-found position and left uncovered.

3.2.16. Plumbing drains with p-traps. Plumbing drains with empty p-traps shall be sealed or filled with water.

3.2.17. Vented combustion appliances. Vented combustion appliances shall remain off or in “pilot only” mode for the duration of the test.

F-1.1 Large Building Infiltration Testing

Verifiers are encouraged to test the building as a whole, and if needed, to reach out to and attempt to contract a more experienced testing professional. Phius is open to alternative methods of testing as long as a proposed work scope is provided by the Verifier and [Contact Us](#) in advance of testing.

The building should be prepared for the test in accordance with F-1, [ANSI Standard 380-2016](#).

F-2 Non-Threatening Air Leakage

Exception, for non-threatening air leakage:

- If the airtightness criterion is missed, and the extra leakage can be proven to be due to a non-assembly-threatening leakage element, certification staff may allow that element to be taped off for the purpose of passing the airtightness criterion.
- Projects with openings not listed below may request approval by [Contacting Us](#) to tape such items off prior to the air-tightness test.
- The un-taped test result must be used for the energy model.

Further details are subject to staff interpretation as detailed below.

Non-threatening leakage elements that may be taped upon Phius approval:

- Fire rated entry doors - leakage through operable components
- Entry doors with panic hardware requirements - leakage through operable components
- Entry door thresholds with universal accessibility requirements - leakage at threshold/sweep
- Elevator doors - leakage through operable components into shaft
- Dampers - leakage at seal
- Trash chutes and compactor systems, code required dampened openings like elevator shaft vents, gas meter room vents, coiling doors
- Direct vent gas fireplace – leakage through firebox

- Window mounted space conditioning unit – leakage through unit itself or through gasket inset in window glazing or window frame (some frames present durability risk and certifier has discretion to decline request for taping)

Non-threatening leakage elements already accounted for in the cfm/ft² gross envelope limit. May not be taped:

- Standard casement/TT/awning windows - leakage through operable components
- Standard lift and slide doors - leakage through operable components
- Standard Balcony/French doors – leakage through operable components
- Duct/vent leakage if fully exposed and in conditioned space

Threatening leakage sources. May not be taped.

- Window or door installation - leakage at rough opening
- Duct/vent/wiring - leakage at penetration of exterior wall
- Duct or vent - leakage inside assembly
- Exterior wall mounted space conditioning unit installation– leakage through rough opening

Phius Variance: Barometric/spring loaded dampers could be sealed for the direction of the test that they will be force-failed open by the test. Thus, fresh air intake dampers could be sealed during depressurization, while exhaust dampers could be sealed during pressurization.

The idea here is that whatever small amount of damper gasket leakage will be captured in the opposite direction in which the damper is forced open, so it is at least somewhat accounted for.

Note: It is important to route an additional pressure tap to the exterior for the reference pressure on channel B during the pressurization test. In some cases, when this is not done, the pressurization results are worse than the depressurization.

Related Documents

1. [Acceptable Air Tightness of Walls in Passive Houses – Salonvaara and Karagiozis 2015](#)

Background

The Phius Technical Committee goal was a clear standardized building enclosure metric for all buildings, large and small. ACH₅₀ is not an equitable metric since the volume of a building does not scale at the same rate as surface area. Phius views the primary purpose of the airtightness threshold as the reduction of the risk of building assembly damage due to air-leakage driven

moisture in super insulated assemblies with minimized mechanical systems, and energy efficiency as the secondary purpose.

Testing at 75 Pa aligns with commercial code (IBC, IECC) and U.S. Army Corps of Engineers (as well as U.S. General Services Administration Facilities Standards, ASTM E779, ASHRAE 90.1, and the National Building Code of Canada.)

Appendix G - Phius Multifamily Certification Performance Requirements v2.3

G-1.0 Building Certification

All Phius Certified multifamily projects must meet the certification criteria of the current revision of the programs below at the time the project is permitted:

1. ENERGY STAR Multifamily New Construction (MFNC)
2. EPA Indoor airPLUS
3. DOE Zero Energy Ready Home (ZERH)
4. Additional on-site verification criteria as contained in the [Phius Multifamily Quality Assurance Workbook](#) and in the and associated checklists

G-1.1 Program Eligibility Criteria

G-1.11 Energy Star MFNC Eligibility Criteria

The EPA has released the EPA ENERGY STAR Multifamily New Construction Program (ES MFNC).

The MFNC program is available for all residential⁶² new construction, except single-family detached homes and two-family dwellings. Follow the decision tree to determine which program your multifamily building can use to earn the ENERGY STAR. Additional footnotes regarding eligibility for multifamily buildings are contained in the footnotes of the ENERGY STAR MFNC National Program Guidelines.

Any part of the building that is part of the project that meets the eligibility criteria for these programs shall be fully certified under those programs, with the exception of projects in California, Alaska, and outside the USA. California projects shall follow the ENERGY STAR Certification program requirements from EPA specific to that State.

EPA ENERGY STAR Multifamily New Construction Program Decision Tree

⁶² As of February 19, 2020, "dormitories" and "residence halls" are eligible to earn the ENERGY STAR through EPA's Multifamily New Construction program. Units without bathrooms or kitchens meet the definition of sleeping units in all Paths of the program.

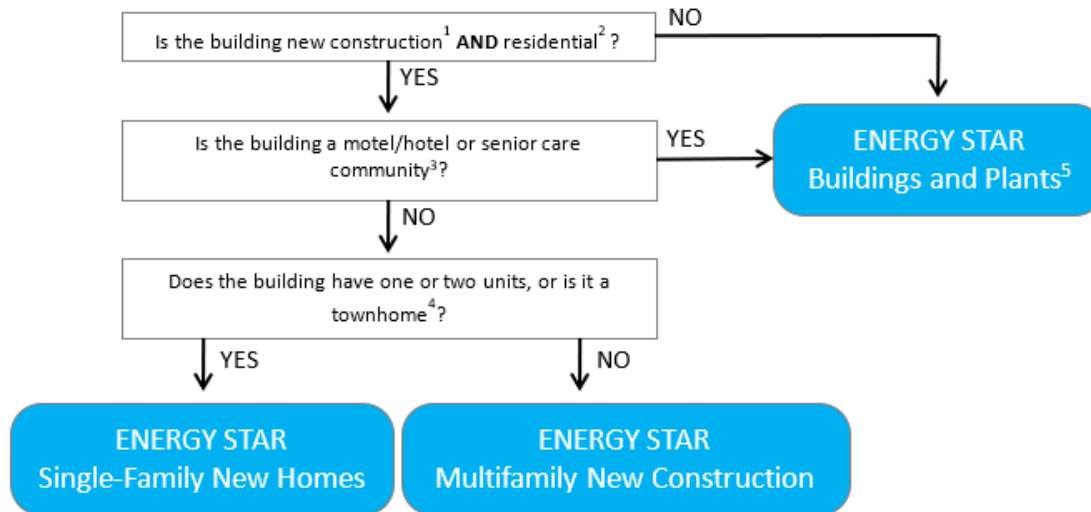

G-1.12 EPA Indoor airPLUS Eligibility Criteria

- Any multifamily buildings with dwelling or sleeping units that is not a two-family dwelling; OR
Mixed-use buildings, where dwelling units and common space exceed 50% of the building square footage
- Residential units in ENERGY STAR MFNC certified buildings of any height are eligible to earn the Indoor airPLUS label, including mixed-use buildings, where dwelling units and common space exceed 50% of the building square footage.
- Residential-associated common spaces, as defined by the ENERGY STAR MFNC National Program Requirements, must also meet the Indoor airPLUS Construction Specifications to earn the Indoor airPLUS label.
- For further clarification, refer to the EPA Indoor airPLUS Policy Record
- When adopted and subject to implementation dates, Phius will require certification under the EPA IAP v2 Program.

G-1.13 DOE ZERH Eligibility Criteria

- Detached single-family homes
- Duplexes
- Townhomes
 - Defined as a single-family dwelling unit constructed in a group of three or more attached units in which each unit extends from the foundation to roof and with open space on at least two sides.

- Multifamily and mixed-use buildings with dwelling or sleeping units no taller than 5 stories above grade, where the dwelling units, sleeping units, and common space exceed 50% of the building's square footage.
 - For further clarification refer to the [DOE ZERH v1 Rev08](#) Specifications
- When adopted and subject to implementation dates, Phius will require certification under the DOE ZERH Version 2 and DOE ZERH for Multifamily

G-1.14 Non-Eligible Buildings

Any Multifamily buildings that are not eligible for certification based on the Program's eligibility criteria shall not be required to do so for Phius certification. However, the certification checklist criteria for these programs shall still be achieved, with all program requirements and checklists applied "as if" they will be certified and documented through the Phius Multifamily Quality Assurance Workbook and associated checklists, specifically:

- Building envelope construction checklist items for air sealing, thermal bridging reduction, and water management strategies as specified by the ES MFNC program shall be met for the entire project.
- HVAC design, installation, testing and commissioning checklist items shall be met for all dwelling units within the project, while HVAC systems for common spaces shall meet the design and commissioning requirements specified by ES MFNC and this Standard.
- IAP and DOE ZERH requirements that affect dwelling units (the use of ENERGY STAR appliances, efficient lighting, hot water temperature rise testing) shall be implemented for all dwelling units.
- All other program criteria (heating/cooling ducts within conditioned space, high-efficacy lighting, ENERGY STAR appliances, solar-ready construction, and EPA Indoor airPLUS certification criteria) shall be met for the entire project.

G-1.2 Effective Date

The v2.3 standard for certification of multifamily buildings is required if either of the following are true:

- Building permit date is on or after July 1, 2021
- Contract date with Phius is on or after February 1, 2022

For projects with a contract or permit date before those noted above shall be encouraged but not required to follow v2.3 protocol and shall achieve certification based on the certification criteria required at the time of the [Phius contract execution](#).

G-1.3 Phius Certified Rater/Verifier

See Appendix E: Phius Certified Rater/Verifier Manual

G-2.0 On-Site Verified Performance Criteria

G-2.1 Sampling

Phius accepts Sampling as a method for streamlining on-site verification by Phius Certified Rater/ Verifier. If the project is being verified by a Phius Certified Rater/ Verifier who is in good standing with a RESNET Sampling Provider, they shall have their plan for implementing Sampling approved by their Provider prior to Sampling being implemented. Where the Rater/Verifier is not a RESNET Rater working with a Sampling Provider, project Sampling plan must be submitted to Phius' QA/QC Manager for approval prior to implementation of Sampling. Approved Sampling plan shall be no less stringent than the Sampling policies and procedures specified by the RESNET Chapter 6 Standards. Documentation of execution of Sampling plan shall be submitted to Phius' QA/QC Manager as part of the final submission package of on-site project documentation.

The following dwelling unit-level on-site verification measures are likely candidates for implementation of Sampling controls:

- Compartmentalization testing.
- Duct system tightness testing.
- Ducted heating, cooling and ventilation air volume measurement and balancing.
 - If project has hired third-party air volume measurement and balancing professional other than the Rater/MF Verifier to conduct air volume measurement and balancing, Rater/MF Verifier shall be responsible for repeating the air volume measurement testing on 10% of dwelling units (maximum of 10, minimum of 3), whichever is greater. Any failures identified by the Rater/MF Verifier shall be corrected, and an additional unit shall be added to Rater/MF Verifier verified tally to ensure project failures are either isolated occurrences or are appropriately fixed.
 - If a project has hired third-party professionals as described above, Rater/MF Verifier shall not be responsible for repeating common space ducted HVAC system air volume measurements. However, testing professionals shall submit documentation of this test to Rater/MF Verifier as described below.
- ZERH hot water distribution efficiency test.
- Bedroom pressure balancing for units with ducted HVAC systems
 - Per ES MFNC standards, bedrooms shall be pressure balanced to +/- 3 Pa for dwelling units with ducted heating and cooling systems.

- o Per Phius standards, bedrooms shall also be pressure balanced to +/- 1 Pa for dwelling units with ducted ventilation systems.
- External static pressure testing of forced air heating and cooling systems.
- Spot ventilation air volume measurements to comply with ES MFNC standards.
- Verification of insulated assemblies, mechanical systems, lighting and appliances.
- All other ES MFNC and ZERH Rater-verifiable checklist requirements.

In addition to dwelling-unit-level measures, the Rater/MF Verifier may also implement a customized sampling plan for common space building envelope and mechanical system verification. A written plan for sampling of these additional measures must be submitted to Phius' QA/QC Manager for review prior to execution.

G-2.2 Whole-building air tightness Testing

Whole-building infiltration testing shall be performed by the Phius Certified Rater/Verifier for each detached building in certification project. Testing shall be conducted using multi-point infiltration procedures as specified in [Appendix F](#), as well as additional guidance specific to multifamily building testing included in the [RESNET Guidelines for Multifamily Energy Ratings](#) document.

If a single blower door fan is utilized for testing, the Rater/MF Verifier shall use an automated multi-point testing software such as The Energy Conservatory *TECTITE* or Retrotec *Fantestic* software. If multiple fans are used, it is recommended that the test be performed using a multi-fan control testing software such as The Energy Conservatory *TECLOG* software. Alternative testing methodologies proposed by the Rater/MF Verifier must be presented in writing to the Phius QA/QC Manager and will be considered on a case-by-case basis.

Details on air-tightness criterion can be found in [Section 3.1](#).

For attached multifamily housing developments without a common access point to perform testing of all building common spaces and dwelling units, achieving uniform test pressure from a single testing location will likely be impossible. This will often be the case for attached townhouse developments, or apartment buildings without common enclosed hallways with doorways connecting the dwelling units to the common space. In such cases, multi-zone whole building testing shall be required, which will necessitate the use of multiple fans set up in multiple testing locations to achieve uniform testing pressure throughout all building zones, and either a multi-fan control testing software must be utilized, or sufficient fan operators must be employed to achieve accurate testing results.

If the nature of the development is such that the number of fans and/or fan operators needed to achieve uniform multi-zone testing conditions to assess whole-building infiltration result is beyond the ability of the project to reasonably coordinate (example: a 20-unit attached

townhouse development, which would require 20 simultaneously running blower door tests to create a uniform result), the project shall use the following testing protocol:

2.2.1 Individual zone, “unguarded” testing

- Each unique building zone shall be tested individually, without adjusting the pressure of adjacent zones.
- The test results shall be adjusted using the coefficients provided in the *Guidance for modeling infiltration results for dwelling units in multifamily residential buildings* section of the [RESNET Guidelines for Multifamily Energy Ratings](#) document.
- All coefficient-adjusted test results for each individual zone shall be added together. The total sum of all project zone test results shall comply with the whole-building infiltration threshold.

2.2.2 Individual zone, “guarded” testing

- In general, “guarded” blower door testing of individual dwelling units is undesirable due to a lack of confidence in the isolation of individual dwelling unit infiltration to outdoor results. However, certain cases may require implementation of such a strategy to isolate the infiltration to outdoors of an individual dwelling unit.
- The strategy below shall only be allowed if an appropriate whole-building test is unable to be performed, and where dwelling units achieve the following prescriptive measures:
- All penetrations in dwelling unit enclosure shell shall be sealed, including pipes, wires, light fixtures, vent fans, duct/ventilation boots, light switches, electrical outlets, etc. so as to prevent leakage between the dwelling unit and other adjacent spaces.
- If electrical conduit is used to connect electrical fixtures or junction boxes, the conduit shall be sealed at each fixture or junction box to prevent air leakage within the conduit. Additionally, if each dwelling-unit contains an electrical service panel, the conduit leading from the service panel to outside of the dwelling unit shall be sealed.
- Dwelling unit bottom and top plates shall be sealed using appropriate sealing products, such as high-quality caulk, air sealing tape, foam gasket product, etc.
- Partition walls between dwelling units shall be capped at the top of the wall so as to prevent air leakage into the interstitial ceiling cavity space. In addition, solid blocking material shall be installed above partition walls for the entire perimeter of the dwelling unit so as to create a sealed ceiling cavity space directly above the dwelling unit. Any wires, pipes, ducts or other penetrations running through this blocking shall be sealed so as to prevent leakage into adjacent building chase spaces.
- For dwelling units with attic space above, ideally a fully sealed partition wall would extend from the attic floor to the roofline so as to isolate the attic space of each dwelling unit. Where this is not possible or practical, Rater/MF Verifier measured zonal pressure

testing shall be conducted while performing individual unit blower door tests to determine unit pressure connection to the attic space. The attic zonal pressure reading shall be 49 Pa or higher (more isolated) in comparison to the pressure within the dwelling unit while the dwelling unit is depressurized to -50 Pa.

- If the above criterion is met, the “guarded” testing strategy described below shall be accepted.
- Blower doors are installed in individual dwelling units to be tested. Blower door is also installed in each directly adjacent building zone surrounding the dwelling unit. (Example 1: A middle floor, interior apartment has 4 directly adjacent building zones – the unit above, the unit below, and the units on either side of the tested dwelling unit. Example 2: a townhouse end-unit has one directly adjacent building zone.)
- All fans are set to depressurize their respective zones to uniform test pressures. Multi-point testing shall be required and repeated for pressurization. The pressurization and depressurization results shall be averaged.
- This testing protocol shall be completed for all individual zones of the building. The averaged zone leakage rate for each individual zone shall be added together. The total sum of all project zone test results shall comply with the whole-building infiltration threshold.

2.2.3 Zone linking method

- An additional alternative may be employed whereby attached multifamily dwellings without common corridors to link them together may be linked through an approved “zone linking” method.
- Zone linking refers to connecting attached dwelling units together from a pressure perspective with some form of conduit connecting the zone of the building where the testing fan is installed and adjacent zones that will not have a testing fan installed.
- Examples of zone linking methods include using well sealed flex duct and taped transitions into windows of adjacent spaces, or using duct work of central ventilation systems. Using these methods, several zones can be linked together from a pressure perspective, allowing whole-building testing to be performed.

Any method of zone linking used will be required to be documented with Phius prior to field execution. Once approved, the method may be used, but care must be taken during the test to ensure that all linked zones achieve the minimum testing pressure (i.e., a linked zone is depressurized to -50 Pa the same as the location of the testing fan). If consistent pressure cannot be maintained between zones (5 Pa) then either the conduit size must be increased in size, or additional fans may be required for testing to achieve consistent pressure.

G-2.3 Dwelling unit compartmentalization

Requirement⁶³: ≤ 0.30 CFM₅₀/sqft of dwelling unit shell area

Individual dwelling unit compartmentalization testing shall be performed to test the air barrier integrity of each dwelling unit. Testing shall be performed as an “unguarded” test as described under the section *Procedures for Multifamily Dwelling unit/Building Air Tightness Testing, Test 1* from the [RESNET Guidelines for Multifamily Energy Ratings](#) document, and shall not be adjusted by any multifamily infiltration correction coefficient.

Dwelling unit compartmentalization testing shall be performed in single-point depressurization mode following RESNET Chapter 8 protocol unless the testing condition at the time of the test qualifies as a *Reduced Level of Accuracy* testing condition per RESNET Chapter 8. Any adjustments for temperature, altitude or reduced accuracy as specified by Chapter 8 shall be applied to the measured CFM@50 Pa leakage rate.

This adjusted compartmentalization value shall be divided by the square footage of the dwelling unit enclosure shell area to demonstrate compliance with this requirement. For apartment-style dwelling units, “band joist” surface area accounted for as the perimeter of the ceiling cavity space of the dwelling unit shall be applied to the lower dwelling unit, and shall only be added if the entire perimeter of the ceiling cavity space is blocked and sealed (i.e., an open floor truss that is not blocked for the ceiling cavity spaces between building zones cannot have the “band joist” surface area included in this calculation.)

G-2.4 Heating and cooling air distribution system tightness testing

All heating, cooling and ventilation air distribution systems shall comply with the following:

- Located inside conditioned space (heating and cooling ducts only)
- Dwelling units
 - Comply with all HVAC design, installation and testing requirements of ESv3 Checklists
- Common spaces
 - Be designed, sized and installed according to all local and municipal code requirements by the project engineer or HVAC contractor,
 - Be constructed, installed and sealed per SMACNA Duct Construction Standards based on Class rating of duct system or the municipal mechanical code requirement where the project is permitted, whichever is more stringent.
 - Common space load calculations and duct designs submitted to the Phius Certified Rater/MF Verifier for documentation.

⁶³ This requirement will be revised to 0.23 CFM₅₀/sqft of dwelling unit shell area upon adoption of EPA indoor airPLUS version 2.

- o Duct tightness testing performed by either the Rater/MF Verifier, HVAC contractor or third-party air balancing firm to demonstrate compliance with SMACNA HVAC Air Duct Leakage Test Manual thresholds or the municipal mechanical code requirement where the project is permitted, whichever is more stringent.
- o Tests completed by a party other than the Rater/MF Verifier shall be documented and sent to Rater/MF Verifier for documentation.

G-2.5 Heating, cooling and ventilation air distribution system measurement and balancing

HVAC air volume measurement and balancing shall be performed for all ducted heating, cooling and ventilation systems. All measurements shall be performed by the Phius Certified Rater/MF Verifier unless a certified third-party air balancing contractor has been hired by the project team to perform air volume measurements and balancing. If no third-party air balancing contractor has been hired and Rater/MF Verifier is not experienced or qualified to perform system balancing, the project HVAC installing contractor shall be responsible for system air volume balancing, and the Rater/MF Verifier shall perform air volume measurements to confirm that air volume balancing has been performed and measurements are within design specifications.

Systems shall comply with the following:

- Air balancing reports produced listing the design airflows, tested airflows, locations of registers and grilles for all systems. Submitted to the Phius Certified Rater/MF Verifier for review and documentation.
- Dwelling units
 - o Comply with all air volume measurement and balancing requirements of ES MFNC program and *Phius On-site Quality Control Workbook for Multifamily Projects*.
- Common spaces
 - o Comply with all air volume measurement and balancing requirements of local and municipal codes.
 - o Exhaust ventilation systems that exert greater than -5 Pa of depressurization shall have make-up air systems with mechanical dampers that open while the exhaust system is operating installed that are sized to relieve depressurization effect. (Refer to [Intermittent Exhaust Allowance Calculator](#))
 - o The Rater/MF Verifier shall document through zonal pressure testing that each zone containing an exhaust system does not depressurize the zone by more than -5 Pa.

G-2.6 Hydronic heating, cooling, and hot water systems appropriately tested and balanced

Hydronic heating and cooling systems fall outside of the scope of ESv3 and ZERH standards. Nevertheless, their design, installation and performance are critical to building performance.

All hydronic heating and cooling systems shall be designed, sized and installed per local or municipal code requirements. Additionally, systems shall be balanced by installing contractor or third-party balancing professionals. It is recommended that balancing be performed following either National Environmental Balancing Bureau (NEBB) *PROCEDURAL STANDARDS FOR TESTING ADJUSTING AND BALANCING OF ENVIRONMENTAL SYSTEMS - SEVENTH EDITION*, ACCA Manual B, or another professional industry-accepted testing and balancing standard. Documentation of balancing shall be provided to Rater/MF Verifier with design flows, tested flows, and locations of all terminal devices.

Rater/MF Verifier shall test hot water distribution effectiveness for each dwelling unit by measuring the temperature-rise of highest volume fixture per ZERH standards. Phius encourages, but does not require, project teams to install demand-based controls for central hot water distribution systems to meet this requirement. Additionally, Phius strongly discourages, but shall not prevent, the use of continuous or time-based hot water circulation systems in multifamily buildings of 6 or more stories and in non-residential projects.

G-2.7 Installed HVAC, pump, motor, and lighting verification and electrical measurement

The Rater/MF Verifier shall perform visual verification that all installed HVAC, pump, motor and lighting equipment meet the specifications of the building design. Where deviations occur, the Rater/MF Verifier shall report findings to the project energy modeler to revise the Phius energy model. Additionally, the Rater/MF Verifier shall perform electrical wattage measurement on installed ventilation systems, or alternatively shall shadow an electrical/mechanical contractor in their measurement of such systems.

G-2.8 Demonstration of compliance with all ENERGY STAR MFNC, EPA IAP and DOE ZERH Certification Criteria

For projects where ES MFNC, IAP and DOE ZERH certification are required, the project team shall choose to comply with either the ES MFNC Prescriptive Path, the ASHRAE 90.1 Path, or ERI Path.

G-2.81 The Phius Path

- Under the ASHRAE 90.1 path, there is an alternate route for Phius projects where the WUFI Passive energy modeling may be used in lieu of the ASHRAE 90.1 modeling.
 - The project may be deemed eligible to meet Energy Star MFNC ASHRAE 90.1 criteria if the calculated Source Energy is at least 10% below the Source Energy Target specific to that project.
- Choosing the ASHRAE 90.1 path requires the use of an EPA approved Multifamily Review Organization (MRO).

Additionally, many utility and state energy efficiency programs offer incentives for HERS-based performance verification, and thus projects may benefit overall from using the ERI Path.

The appropriate version of the ES MFNC, IAP and ZERH standards shall be based on the permit date of the project. Phius also encourages, but does not require, certification under the EPA WaterSense New Homes program. For more information on these programs, please see the following links:

- EPA Energy Star Program Requirements: https://www.energystar.gov/partner_resources/residential_new/program_reqs?s=mega
- EPA Indoor airPLUS Requirements: <https://www.epa.gov/indoorairplus/indoor-airplus-program-documents>
- DOE ZERH Requirements: <https://www.energy.gov/eere/buildings/doe-zero-energy-ready-home-zerh-program-requirements>
- EPA WaterSense Requirements: <https://www.epa.gov/watersense>

G-2.9 Verification of Renewable Energy System Installation, or Renewable Ready

All projects shall either have renewable energy systems installed or shall comply with the DOE Zero Energy Ready Home PV-Ready Checklist, regardless of how much average daily solar radiation the site receives. Sites with significant adjacent shading or insufficient roof area facing true south per the program checklist shall not be required to comply with this requirement.

G-3.0 Energy Model-Based Performance Requirements

See [Section 3](#).

Appendix H – Phius 2021 Target-Setting Updates

Building size and occupant density influence the optimal path to a low energy building. Therefore, the criteria implement continuous adjustments for a range of different building sizes, occupant and unit densities (the adjustments are continuous within a limited range). The sensitivities to building size, occupant density, and unit density are different for each of the four criteria, and change depending on climate.

The space conditioning criteria result from optimizing based on upgrade costs vs. savings in operational energy, and guide building energy planners accordingly.

For PHIUS+ 2018, the basic process for setting the heating and cooling criteria was:

1. Life-cycle cost optimization: Model study buildings in BEopt, giving its optimizer various energy-saving upgrades to weigh.
2. Crossover: Model the study buildings again in WUFI® Passive, with the chosen upgrade packages. This is necessary to tune the criteria to the calculation methods actually used in project certification.
3. Statistical smoothing: Note the resulting annual demands and peak loads for heating and cooling and do curve-fitting on that data to find interpolation formulas. Those formulas then determine the criteria for all cases.

The BEopt study cases from 2018 were also used for 2021, but there were additional optimization cases run on a Tiny house design, and some corrections were made to the Crossover models of the 2018 cases. Therefore, the curve-fitting was also redone.

H-1 Tiny House Study

While the PHIUS+ 2018 study buildings covered a wide range of envelope to floor area ratios, some of the smaller projects submitted for certification ran into difficulty with very tight space conditioning criteria. For phius 2021, a 'tiny house' case was created and run to extend the envelope to floor area ratio of studied buildings from the previous ratio of 3.07 up to 9.20. Forty cases were run (using BEopt 2.8) comprising two different occupancy levels (one or two people), each in twenty climate locations. Fixed parameters of the 'tiny house' are noted below. It was inspired by the "Bodega" design from Tumbleweed Tiny House Company.

- iCFA: 146 to 229 square feet, depending on the wall package chosen by BEOpt. (Base iCFA was 192 ft².)
- 18 ft (long) x 14 ft (wide)
- 16' tall with 12:12 gable roof
- 14% Window-to-wall ratio
- Oriented facade-south
- Foundation: Assumed pier-and-beam – floor was considered in contact with outer air.



Design inspiration for the Tiny house study cases.

Unlike for some of the 2018 study buildings, the window sizes and locations remained static. Otherwise the variables and constraints for the optimization were set as for the 2018 study, including IECC code minimums. In the crossover models, the exterior dimensions were kept fixed but the floor area was adjusted depending on the wall thickness.

H-2 Revised Curve-fits for Space Conditioning Targets

In the fitting of regression formulas for the heating/cooling performance to functions of the climate factors, the Tiny houses did not fall into the same pattern as the 2018 study buildings. Therefore, a separate set of formulas was fitted to the Tiny house results. The phius 2021 criteria calculator interpolates between the two sets of criteria formulas based on the building floor area. For buildings with over 1000 ft², it just uses the updated 2018 criteria, and limits the envelope-to-floor area adjustment to the range studied in 2018 (0.71 to 3.07). For buildings between 200 and 1000 ft², it interpolates linearly, and below 200 ft² it uses the Tiny house formulas.

The following changes were made in refitting the regression formulas for the 300 case studies from 2018:

- The WUFI Passive Crossover models were recalculated using the new shading algorithm.
- Window areas in the Crossover models were corrected (lower) for some of the cases.
- Unit density was tested as a predictor along with the occupant density. For the Annual Heating and Cooling Demands, unit density was found to be a better predictor than occupant density. The peak loads were sensitive to both, but not strongly.
- The formula for the Peak Heating Load limit now uses the heating design-day temperature of the clear-cold day (THD-1), as one of its predictor variables, instead of the average of the two design-day temperatures. For most projects the clear-cold day condition calculates a higher heating load than the cloudy, warmer day (THD-2).

Therefore, using THD-1 in the curve-fitting slightly improved the fit and raised the peak heating load limit in the warm climates.

The *best-fit* climate-sensitive regression formulas for the heating and cooling criteria are shown in Appendix A, for both the Tiny homes and the Non-Tiny. As was done for the [2018 mid-cycle update](#), the Criteria calculator actually uses *inclusive-fit* formulas for all the criteria except the annual heat demand. The inclusive fit adds an additional allowance of 120% of the RMS error.

On average, for the study buildings and for 52 recent projects, these changes resulted in about an 11% loosening of the annual heating demand target and about a 14% tightening of the annual cooling and peak cooling targets, with little average change in the heating load target, compared to 2018.

Climate factors included:

- (1) HDD65: Heating Degree Days, base 65F
Source: ASHRAE Fundamentals 2017
- (2) CDD50: Cooling Degree Days, base 50F
Source: ASHRAE Fundamentals 2017
- (3) IGA [kWh/m².yr]: Solar Irradiance, Global, Annual
Source: Meeonorm
- (4) DDD [lb/lb.days]: Dehumidification Degree Days, base 0.10 lb/lb
Source: Meeonorm
- (5) THD [F]: Peak Heating Design Temperature
Source: Meeonorm
- (6) TCD [F]: Peak Heating Design Temperature
Source: Meeonorm
- (7) DDHR [grains/lb]: Dehumidification Design Humidity Ratio 0.4%
Source: ASHRAE Fundamentals 2017
- (8) IGHL [BTU/hr.ft²]: Peak Heating Solar Radiation
Source: Meeonorm
- (9) IGCL [BTU/hr.ft²]: Peak Cooling Solar Radiation
Source: Meeonorm
- (10) Pelec [\$ /kWh]: Marginal cost of electricity

The marginal cost of electricity, in \$/kWh, was used as an independent factor in the experiment, to determine its impact on the resulting space conditioning targets. That is, its value was not tied to the city used, but rather test values were used to explore a full range of options.

To choose the upgrade package, the optimal, minimum life-cycle cost point was chosen for all cases, rather than manually choosing a point of diminishing returns on the cost curve as before in 2015.

Crossover to WUFI Passive

In the crossover study, the 300 optimized buildings were re-modeled in WUFI® Passive, adding only a few effects from Phius protocol that BEopt neglects, such as window installation, thermal bridge coefficients, and corridor ventilation. It was challenging to match the ground contact modeling procedures between the two software, so workaround measures were taken to simulate uninsulated slabs with only perimeter insulation.

Curve-Fitting

In the curve-fitting, each of the four criteria was fitted to a “response-surface” type of function in terms of envelope-to-floor-area-ratio (EnvFlr), occupant density (Occ) and three to five of the relevant climate factors. For example, Annual Heat Demand was fitted to a function of EnvFlr, Occ, HDD65, IGA, and Pelec. Such functions consist of a sum of several terms or “effects”: a constant, terms linearly proportional to each of the factors, terms proportional to the squares of the factors, (quadratics) and terms proportional to the two-way cross products of the factors (interactions). The constants of proportionality are adjusted by least-squares regression for the best fit. Effects that were not statistically significant were dropped from the fitted formula. The software used for this statistical analysis was JMP 13.

For the most part, the climate dependence in the resulting formulae for the heating/cooling targets behaves in an intuitive way – places with hotter design days are allowed more peak cooling load and so on. However, this is not always the case. Keep in mind that there has been an optimizer at work that is “trying” to compensate for climate variation; it chooses different upgrade packages for different conditions, so it may go against expectations based on “other things being equal” type of thinking. This is particularly so for the Annual Heat Demand, because that is typically where most of the energy savings comes from; therefore it interacts with the cost-optimization more strongly than the other heating/cooling metrics.

H-3 Prescriptive Path Airtightness Limit

This is tighter than the limit set for projects taking the performance route because:

1. Air-tightness was shown to be a cost-effective measure in the cost-optimization studies used to set the performance targets. Therefore, the study buildings used for the target-setting process often used better than required air-tightness. So, this tighter limit helps provide more consistent results with the performance path.
2. Project teams have also found over-performing on air-tightness to be a good strategy

Appendix I – Informative

I-1 Tips for Passive Building Design

I-1.1 Tips to Design a Low-Cost Passive Building

- Keep the thermal envelope simple (add "architectural interest" outside of it).
- Keep window area down (10-15% of wall area for single-family houses).
- For small buildings, design a compact shape.
- For large buildings, bump-ins for daylighting may be more important.
- Limit "open to below" areas on the floor.
- Not too "tiny" and detached – design attached housing with small units instead.
- Use details that do not require excessive labor to air-seal (avoid "conceptual retrofitting").

I-1.2 Tips on Assemblies

I-1.2.1 Air Barrier

- Mid-wall is the best place for the air barrier. Exterior/interior placement is more vulnerable.

I-1.2.2 Perfect Wall

- Keep in mind the "perfect wall" concept - structure to the inside, insulation to the outside. Diffusion open or exterior rigid foam, both versions can work moisture-wise and super-insulated. [⁶⁴] [⁶⁵]

I-1.2.3 Slab Construction

- Moisture barrier and air barrier are typically placed between the foam layer and slab.
- Polyisocyanurate (PolyIso) insulation is typically not to be used below grade. [⁶⁶] Thoroughly follow the application guidance of the manufacturer's warranty and any ICC Evaluation Service report that pertains.

⁶⁴ Lstiburek, Joseph. "BSI-001: The Perfect Wall." Building Science Corporation, 15 July 2010. Web. 16 May 2016.

<http://buildingscience.com/documents/insights/bsi-001-the-perfect-wall>

⁶⁵ "BSI-091: Flow-Through Assemblies." Building Science Corporation, 13 Jan. 2016. Web. 16 May 2016.

<https://buildingscience.com/documents/building-science-insights-newsletters/bsi-091-flow-through-assemblies>

⁶⁶ "Home » Green Basics: Encyclopedia » Envelope and Structure » Insulation Choices » Rigid Foam Insulation." Green Building Advisor. The Taunton Press, 9 Aug. 2012. Web. 16 May 2016.

<http://www.greenbuildingadvisor.com/green-basics/rigid-foam-insulation>

I-1.2.4 Assembly R-Values

| R-value Ranges* (hr.sf.F/Btu) | | | | | | | | | | | |
|--|------------------|------------|-------------|-------------|-------------|-------------|-------------|------------|-------------|-------------|-------------|
| Climate Zone | 0 & 1 | 2 | 3A/B | 3C | 4A/B | 4C | 5A/B | 5C | 6 | 7 | 8 |
| Walls & Overhanging Floors (Above Grade) | 20-24 | 20-28 | 24-40 | 28-32 | 28-48 | 28-44 | 32-48 | 36-46 | 40-68 | 44-92 | 52-160 |
| Roofs | 48-56 | 52-60 | 52-68 | 56-60 | 64-76 | 56-72 | 60-80 | 64-76 | 72-96 | 76-120 | 76-172 |
| Walls & Floors (Below Grade) | 1-16 | 8-16 | 8-20 | 12-16 | 16-28 | 12-28 | 16-32 | 16-28 | 20-48 | 24-60 | 32-100 |
| Ceilings (Unconditioned Basement / Crawlspace) | 7-22 | 14-22 | 14-26 | 18-22 | 22-34 | 22-34 | 22-38 | 22-34 | 26-54 | 30-66 | 38-106 |
| U-value Ranges* (Btu/hr.sf.F) | | | | | | | | | | | |
| Climate Zone | 0 & 1 | 2 | 3A/B | 3C | 4A/B | 4C | 5A/B | 5C | 6 | 7 | 8 |
| Windows & Doors (Whole-Window) | 0.5 - 0.29 | 0.5 - 0.23 | 0.47 - 0.19 | 0.39 - 0.25 | 0.23 - 0.16 | 0.37 - 0.18 | 0.24 - 0.13 | 0.27 - 0.2 | 0.19 - 0.11 | 0.22 - 0.09 | 0.19 - 0.08 |

*Values represent the range of prescriptive assembly performance values for Phius' prescriptive standard that applies to detached single-family, attached single-family and townhomes. Phius' required performance values vary by city and are not based on climate zone. Larger projects (multifamily and non-residential) are not represented in the performance ranges described above.

I-1.3 Tips on Windows

I-1.3.1 Window Certification Program

- It is generally recommended to follow the zone-by-zone guidelines on the [Phius Certified Data for Window Performance Program](#) page and to review Phius' requirements for window comfort and to avoid condensation risk.

I-1.3.2 Window Condensation

- Regarding Exception 3 of [N-4](#): Supplying heat at the room edge would not necessarily solve condensation problems - if there is a significant window niche the warm convection flow would tend to bypass it and leave the corners cold and stagnant. The condensation risk requirements cannot be met through supplemental heating. Windows should not need additional heating to prevent condensation.

I-1.3.2 Window Comfort

- Regarding Exception 3 of [N-4](#): Supplying heat at the room edge is a non-passive approach; it may not work, and this is harder to calculate. This tactic should help from a comfort point of view. but it is less clear that it would solve a condensation problem - if there is a significant window niche the warm convection flow would tend to bypass it and leave the corners cold and stagnant. The condensation risk requirements cannot be met through supplemental heating. Windows should not need additional heating to prevent condensation.

I-1.4 Tips on Ventilation

I-1.4.1 Exhaust Ventilation Devices

- Consider moving an exhaust dryer to the mudroom or outside the thermal envelope.
- Make-up air for a directly vented range hood is acceptable as long as the total meets the source energy requirements. If a make-up air system is planned then it can be tied directly to a vented dryer as well, i.e. it comes on when the dryer is running and venting.
- Refer to the [Intermittent Exhaust Allowance Calculator](#).

1-1.4.2 Ventilation Fresh Air Supply

- Dedicated ventilation ductwork is best practice.
- MERV 12 or higher is recommended for filtration of the ventilation air.
- When outdoor PM2.5 is >40, it is recommended to use a MERV 16 or HEPA filter on outdoor air duct to yield an indoor PM2.5 <12⁶⁷

I-1.4.3 Ventilation System Capacity

- It is recommended that the ventilation system is capable of at least 0.3 ACH (air changes per hour) based on the net volume at its maximum setting. This is not required.

I-2 Source Energy

The metric used for this criterion is net source energy use. The overall energy limit is based on source energy because that is a good measure of the impact the building's operation has on society. That impact consists mostly of CO₂ emissions, but the source energy metric differs from carbon-scoring in that it includes the impact of nuclear power as well.

⁶⁷ "Selecting Ventilation Air Filters to Reduce PM2.5 Of Outdoor Origin." ASHRAE Journal. September 2016. http://www.conforlab.com.br/wp-content/uploads/2016/10/2016Sep_012-021_HarrimanFiltersToReducePM2.5.pdf

I-2.1 Source Energy Factors for Grid Electricity

In past versions of the Phius certification program, the source-site ratio for grid electricity was defined by the [Energy Star Portfolio Manager](#) and was determined based on past generation and consumption data from the [Energy Star Portfolio Manager](#).

Moving forward, Phius will use a source energy factor for grid electricity that reflects a future outlook. The intent is to reflect future conditions more appropriately and to better weigh the impact of using electricity versus natural gas on-site. For projects in the US, Phius 2021 uses a source energy factor based on a projected 2050 electricity generation mix. This future source energy factor was calculated from NREL's MidCase scenario in 2050, as reported in their [2020 Standard Scenario Report](#). This report details the future grid generation resource mix based on policies that were in place as of June 30, 2020. A full calculation methodology report can be found in the Tech Corner Article: [Phius 2021 Future Electricity Source Energy Factors](#). 2050 is the furthest year out that the data is projected to and is roughly a midpoint on the anticipated life of a building built today.

I-2.2 Net Zero Source Energy

For an all- electric building, the same on-site PV array (or PPA, etc) that gives site zero also gives source zero. It is different if the building uses other fuels - for example if the building made heavy use of biomass for heating, the overall source/site ratio of its usage might be only 1.5, while the source/site ratio of the PV is 1.8. Therefore, on that building the PV array size for source zero would be smaller than the array size for site zero, because of the additional source-reduction strategy.

Note: In setting the source energy limit to zero, it is unproductive to put the entire burden on the building and its on-site production potential. Doing so may push past the point of diminishing returns in energy conservation or prohibit projects with constrained sites from ever achieving this goal. At some point, the building has conserved and generated all it can, and the focus will shift to cleaning up the energy supply.

I-3 Raters and Verifiers

We recommend contacting a Phius Certified Rater/Verifier as soon as certification becomes a goal for the project and incorporate them into the project team early on. Phius asks that you hire a Rater/Verifier when you submit a project contract to Phius at the start of Certification.

Phius acknowledges that the addition of this component to our certification does raise fees. However, we also feel strongly that it helps create higher quality buildings.

Phius has not set a fee structure for the Phius Certified Raters/Verifiers to charge for their services. For a single-family home, expect 20 hours of work (plus travel time) at the Phius Certified Rater/Verifier's hourly rate (typically \$100-\$200 per hour depending on market). This

does assume a relatively straightforward process. Significant problems could result in more time needed, but simple homes may expect less time for completion.

Be aware that travel can significantly affect the quote the project team receives from a Phius Certified Rater/Verifier.

[Find a Phius Certified Rater or Verifier](#)

I-3.1 Overview of Typical Site Visits for the Rater/Verifier:

1. Sub-slab insulation check.
2. Preliminary blower door test.
3. Insulation quality check.
4. Final blower door, ventilation commissioning, final Quality Assurance Workbook.

Coordination of the site visits and design review by the Phius Certified Rater/Verifier should occur between the Rater/Verifier and the project team. The number of site visits is up to the Rater/Verifier. Phius encourages in-person sub-slab insulation inspection, but procurement of onsite photos is allowed. Preliminary blower door testing is optional, but strongly encouraged.

More details can be found in [Appendix E Sections 3-5](#).

I-4 Fireplaces

In an airtight house there is great danger of back drafting or for the fireplace/stove using the interior air for combustion. The combustion intake air must be directly from the outdoors and independent of the interior air supply. Warning systems should be considered such as carbon monoxide detectors or depressurization sensors. If the building gets depressurized for some reason (one of the ventilator fans fails and the defect goes unnoticed) then, despite of all the precaution of airtight fire box and dedicated combustion air, back drafting could still occur and draw potentially life-threatening gasses into the interior of the building.

Fireplace Disclaimer: The use of a fireplace/woodstove in a home can be dangerous due to the risk of carbon monoxide poisoning. The fireplace/woodstove specified for this home must be completely airtight to the room air. Combustion air must be provided by a dedicated pipe connecting to the outside. If smoke is seen to be leaking from the stove into the living area, immediately open all the windows, and discontinue using the stove. **DO NOT LEAVE A FIRE BURNING UNATTENDED** especially when going to sleep at night. Carbon monoxide detectors should be installed in locations so that they can be heard throughout the house. Phius (the Passive House Institute US) or any of its employees are not responsible for any damage, injury or death caused.

Appendix J - Co-Generation

There are two ways to operate a combined-heat-and-power (CHP) unit:

- On electrical demand. (E-Priority)
 - CHP is run independently of the heating load, with the intent of producing electricity, and the heat production is a byproduct, which may or may not be usable.
- On heating demand. (H-Priority)
 - CHP is run to match the heating demand (hot water and/or space heat), and the electricity produced while the CHP operates is regarded as a byproduct, that is either used on site or sold to the grid.
 - The H-priority path in turn has two variants depending on whether the backup heat is supplied by electricity or fuel combustion. The calculation protocol is implemented in the [Phius Co-Generation Source Energy Factor Calculator](#).

With a combined-heat-and power (CHP) unit, the adjusted annual source energy for the building is given by: $PE = D_{ELEC}F_{ELEC} + D_{HEAT}F_{HEAT}$

where

D_{ELEC} is the annual electricity demand of the building (excluding any supplemental heat provided by grid electricity.)

D_{HEAT} is the annual heating demand plus hot water demand (including storage and distribution losses) of the building.

F_{ELEC} is the adjusted PE factor for electricity.

F_{HEAT} is the adjusted PE factor for heating.

The adjusted SE factor for electricity F_{ELEC} is given by

$$F_{ELEC} = \frac{E_{CHP}F_{E,CHP}}{D_{ELEC}^*} + \frac{(D_{ELEC}^* - E_{CHP}) \cdot F_{E,GRID}}{D_{ELEC}^*}$$

The annual electrical energy production E_{CHP} by the CHP units / generators is given by

$$E_{CHP} = \begin{cases} \text{the intended amount, for E-priority} \\ D_{HEAT} K_{COVG} \cdot \frac{\eta_{ELEC}}{\eta_{HEAT}}, \text{ for H-priority} \end{cases}$$

η_{ELEC} is the electrical generation efficiency of the CHP units (e.g. typically 25%.)

η_{HEAT} is the heat and hot water generation efficiency of the CHP units (e.g. typically 50%.)

$F_{E,GRID}$ is the source energy factor for grid electricity (currently 3.16).

$$D_{ELEC}^* = \begin{cases} D_{ELEC} + H_{GRID}, & \text{for H-priority with grid electric backup heat} \\ D_{ELEC}, & \text{otherwise} \end{cases}$$

H_{GRID} is the supplemental heat from grid electricity on the H-priority path with electric backup, given by

$$H_{GRID} = D_{HEAT} \cdot (1 - K_{COVG})$$

K_{COVG} is the fraction of the heat demand intended to be covered by CHP for H-priority, e.g. 90%.

The source energy factor for electricity from CHP, $F_{E,CHP}$, is given by

$$F_{E,CHP} = \begin{cases} F_{FUEL} / \eta_{ELEC}, & \text{for E-priority} \\ 0, & \text{for H-priority} \end{cases}$$

in which F_{FUEL} is the source energy factor of the fuel for the CHP units (e.g. currently 1.07 for gas.)

The adjusted PE factor for heating F_{HEAT} is given by

$$F_{HEAT} = \begin{cases} \frac{(H_{CHP} \cdot K_{UTIL}) F_{H,CHP} + (D_{HEAT} - H_{CHP} \cdot K_{UTIL}) \cdot F_{FUEL}}{D_{HEAT}}, & \text{for E-priority} \\ K_{COVG} \cdot F_{H,CHP} + (1 - K_{COVG}) \cdot F_{FUEL}, & \text{for H-priority with fuel heat for backup} \\ F_{H,CHP}, & \text{for H-priority with grid electric heat for backup} \end{cases}$$

where the annual CHP heating byproduct H_{CHP} is given by

$$H_{CHP} = E_{CHP} \cdot \frac{\eta_{HEAT}}{\eta_{ELEC}}$$

K_{UTIL} is the usable fraction of CHP heat (if CHP heat is available when the building needs heat, $K_{UTIL} = 1$). This may require an additional side calculation, depending on how the CHP unit is intended to run.

The source energy factor for heat generation from CHP, $F_{H,CHP}$, is given by

$$F_{H,CHP} = \begin{cases} 0, & \text{for E-priority} \\ F_{FUEL} / \eta_{HEAT}, & \text{for H-priority} \end{cases}$$

Appendix K - Electric Vehicle Charging Infrastructure

K-1 Requirements

One- to two-family dwellings and townhouses. One- and two-family dwellings and townhouses with a dedicated attached or detached garage or on-site parking spaces and new detached garages shall be provided with one *EV-Ready space* per dwelling unit. The branch circuit for the *EV-Ready space* shall have a minimum capacity of 9.6 kVA.

Exception: EV-Ready Spaces are not required where no parking spaces are provided.

Multifamily dwellings (three or more units). EV Ready Spaces and EV Capable Spaces shall be provided in accordance with Table **EV**. Where the calculation of percent served results in a fractional parking space, it shall round up to the next whole number. The service panel or subpanel circuit directory shall identify the spaces reserved to support EV charging as “EV Capable” or “EV Ready”. The raceway location shall be permanently and visibly marked as “EV Capable”.

Exception: For retrofit projects with an existing garage, dual 40 amp, 208/240-volt circuits are allowed rather than single 40 amp, 208/240-volt circuits per EV Ready space.

Campus EV Requirements: For a neighborhood or development with multiple buildings where no individual building parking is provided, a “campus” approach can be taken to apply to the EV requirements. In this case, treat the development as a single project and use the total number of parking spaces provided with Table **EV** to determine requirements.

Non-Residential Buildings: TBD

K-2 Definitions

ELECTRIC VEHICLE (EV). An automotive-type vehicle for on-road use, such as passenger automobiles, buses, trucks, vans, neighborhood electric vehicles, electric motorcycles, and the like, primarily powered by an electric motor that draws current from a rechargeable storage battery, a fuel cell, a photovoltaic array, or another source of electric current. Plug-in hybrid electric vehicles are electric vehicles having a second source of motive power. Off-road, self-propelled electric mobile equipment, such as industrial trucks, hoists, lifts, transports, golf carts, airline ground support equipment, tractors, boats and the like, are not considered electric vehicles.

ELECTRIC VEHICLE SUPPLY EQUIPMENT (EVSE). The conductors, including the ungrounded, grounded, and equipment grounding conductors, and the *electric vehicle* connectors, attachment plugs, and all other fittings, devices, power outlets, or apparatus installed specifically for the purpose of transferring energy between the premise’s wiring and the *electric vehicle*.

ELECTRIC VEHICLE SUPPLY EQUIPMENT (EVSE) SPACE. A designated parking space with dedicated electric vehicle supply equipment capable of supplying not less than 6.2 kW to an electric vehicle located within 3 feet of the parking space.

EV-CAPABLE SPACE. A parking space that is provided with conduit that meets the following requirements:

1. The conduit shall be continuous between a junction box or receptacle located within 3 feet of the parking space and an electrical panel serving the area of the parking space with sufficient dedicated physical space for a dual-pole, 40-amp breaker
2. The conduit shall be sized and rated to accommodate a 40-amp, 208/240-volt branch circuit and have a minimum nominal trade size of 1 inch
3. The electrical junction box and the electrical panel directory entry for the dedicated space in the electrical panel shall have labels stating "For future *electric vehicle* charging".

EV-READY SPACE. A parking space that is provided with dedicated branch circuit that meets the following requirements:

1. Wiring capable of supporting a 40-amp, 208/240-volt circuit,
2. Terminates at a junction box or receptacle located within 3 feet of the parking space, and
3. The electrical panel directory shall designate the branch circuit as "For electric vehicle charging" and the junction box or receptacle shall be labeled "For electric vehicle charging".

ELECTRIC VEHICLE LOAD MANAGEMENT SYSTEM. A system designed to allocate charging capacity among multiple electric vehicle supply equipment.

Identification. Construction documents shall indicate the raceway termination point and proposed location of future EV spaces and EV chargers. Construction documents shall also provide information on amperage of future EVSE, raceway methods, wiring schematics and electrical load calculations to verify that the electrical panel service capacity and electrical system, including any on-site distribution transformers, have sufficient capacity to simultaneously charge all EVs at all required EV spaces at the full rated amperage of the EVSE.

Appendix L - Electrification Readiness for Combustion Equipment

Combustion equipment shall comply with the section below.

Combustion water heating: (with a capacity less than or equal to 300 kBtu/h) shall be installed in accordance with the following:

1. A dedicated 240-volt branch circuit with a minimum capacity of 30 amps shall terminate within 3 feet from the water heater and be accessible to the water heater with no obstructions. Both ends of the branch circuit shall be labeled with the words "For Future Heat Pump Water Heater" and be electrically isolated.
2. A condensate drain that is no more than 2 inches higher than the base of the installed water heater and allows natural draining without pump assistance shall be installed within 3 feet of the water heater.
3. The water heater shall be installed in a space with minimum dimensions of 3 feet by 3 feet by 7 feet high.
4. The water heater shall be installed in a space with a minimum volume of 700 cubic feet or the equivalent of one 16-inch by 24-inch grill to a heated space and one 8-inch duct of no more than 10 feet in length for cool exhaust air.

For systems with capacity greater than 300 kBtu/h, see 'Other combustion equipment' requirements at the end of this section.

Combustion space heating: The building shall be provided with a designated exterior location(s) in accordance with the following:

1. Natural drainage for condensate from cooling equipment operation or a condensate drain located within 3 feet, and
2. A dedicated branch circuit in compliance with IRC Section E3702.11 based on heat pump space heating equipment sized in accordance with R403.7 and terminating within 3 feet of the location with no obstructions. Both ends of the branch circuit shall be labeled "For Future Heat Pump Space Heater."

Exception: Where an electrical circuit in compliance with IRC Section E3702.11 exists for space cooling equipment.

Combustion clothes drying. A dedicated 240-volt branch circuit with a minimum capacity of 30 amps shall terminate within 6 feet of natural gas clothes dryers and shall be accessible with no obstructions. Both ends of the branch circuit shall be labeled with the words "For Future Electric Clothes Drying" and be electrically isolated.

Combustion cooking. A dedicated 240-Volt, 40A branch circuit shall terminate within 6 feet of natural gas ranges, cooktops and ovens and be accessible with no obstructions. Both ends of the branch circuit shall be labeled with the words "For Future Electric Range" and be electrically isolated.

Other combustion equipment. Combustion equipment and end-uses not covered by Sections above shall be provided with a branch circuit sized for an electric appliance, equipment or end use with an equivalent capacity that terminates within 6 feet of the appliance or equipment.

Appendix N - Normative

N-1 DHW Distribution Pipe Materials and Sizes

| Ounces of water per foot of hot water tubing | | | | | | | | |
|--|-------------|----------|----------|-----------------|-------------|------------|-------------|---------------|
| Nominal diameter [in] | Copper M | Copper L | Copper K | CPVC CTS SDR 11 | CPVC SCH 40 | PEX-AL-PEX | PE-AL-PE | PEX CTS SDR 9 |
| | 2 | 3 | 4 | 5 | 6 | 7 | 8 | 9 |
| 3/8 | 1.06 | 0.97 | 0.84 | #N/A | 1.17 | 0.63 | 0.63 | 0.64 |
| 1/2 | 1.69 | 1.55 | 1.45 | 1.25 | 1.89 | 1.31 | 1.31 | 1.18 |
| 5/8 | #N/A | 2.32 | 2.22 | #N/A | #N/A | 2.12 | #N/A | 1.72 |
| 3/4 | 3.43 | 3.22 | 2.90 | 2.67 | 3.38 | 3.39 | 3.39 | 2.35 |
| 1 | 5.81 | 5.49 | 5.17 | 4.43 | 5.53 | 5.56 | 5.56 | 3.91 |
| 1 1/4 | 8.70 | 8.36 | 8.09 | 6.61 | 9.66 | 8.49 | 8.49 | 5.81 |
| 1 1/2 | 12.18 | 11.83 | 11.45 | 9.22 | 13.20 | 13.88 | 13.88 | 8.09 |
| 2 | 21.08 | 20.58 | 20.04 | 15.79 | 21.88 | 21.48 | 21.48 | 13.86 |

| Outside diameter [in] | | | | | | | | |
|-----------------------|-------------|----------|----------|-----------------|-------------|------------|-------------|---------------|
| Nominal diameter [in] | Copper M | Copper L | Copper K | CPVC CTS SDR 11 | CPVC SCH 40 | PEX-AL-PEX | PE-AL-PE | PEX CTS SDR 9 |
| | 2 | 3 | 4 | 5 | 6 | 7 | 8 | 9 |
| 3/8 | 0.50 | 0.50 | 0.50 | #N/A | 0.68 | 0.47 | 0.47 | 0.50 |
| 1/2 | 0.63 | 0.63 | 0.63 | 0.63 | 0.84 | 0.63 | 0.63 | 0.63 |
| 5/8 | #N/A | 0.75 | 0.75 | #N/A | #N/A | 0.79 | #N/A | 0.75 |
| 3/4 | 0.88 | 0.88 | 0.88 | 0.88 | 1.05 | 0.98 | 0.98 | 0.88 |
| 1 | 1.13 | 1.13 | 1.13 | 1.13 | 1.32 | 1.26 | 1.26 | 1.13 |
| 1 1/4 | 1.38 | 1.38 | 1.38 | 1.38 | 1.66 | 1.58 | 1.58 | 1.38 |
| 1 1/2 | 1.63 | 1.63 | 1.63 | 1.63 | 1.90 | 1.97 | 1.97 | 1.63 |
| 2 | 2.13 | 2.13 | 2.13 | 2.13 | 2.38 | 2.48 | 2.48 | 2.13 |

| Inside diameter [in] | | | | | | | | |
|-----------------------|-------------|----------|----------|-----------------|-------------|------------|-------------|---------------|
| Nominal diameter [in] | Copper M | Copper L | Copper K | CPVC CTS SDR 11 | CPVC SCH 40 | PEX-AL-PEX | PE-AL-PE | PEX CTS SDR 9 |
| | 2 | 3 | 4 | 5 | 6 | 7 | 8 | 9 |
| 3/8 | 0.45 | 0.43 | 0.40 | #N/A | 0.49 | 0.35 | 0.35 | 0.36 |
| 1/2 | 0.57 | 0.55 | 0.53 | 0.51 | 0.62 | 0.50 | 0.50 | 0.49 |
| 5/8 | #N/A | 0.67 | 0.65 | #N/A | #N/A | 0.64 | #N/A | 0.58 |
| 3/4 | 0.81 | 0.79 | 0.75 | 0.72 | 0.82 | 0.81 | 0.81 | 0.68 |
| 1 | 1.06 | 1.03 | 1.00 | 0.92 | 1.05 | 1.03 | 1.03 | 0.88 |
| 1 1/4 | 1.29 | 1.27 | 1.25 | 1.13 | 1.38 | 1.28 | 1.28 | 1.07 |
| 1 1/2 | 1.53 | 1.51 | 1.48 | 1.33 | 1.61 | 1.63 | 1.63 | 1.26 |
| 2 | 2.01 | 1.99 | 1.96 | 1.74 | 2.07 | 2.03 | 2.03 | 1.65 |

| Weight empty lb/ft | | | | | | | | |
|-----------------------|-------------|----------|----------|-----------------|-------------|------------|-------------|---------------|
| Nominal diameter [in] | Copper M | Copper L | Copper K | CPVC CTS SDR 11 | CPVC SCH 40 | PEX-AL-PEX | PE-AL-PE | PEX CTS SDR 9 |
| | 2 | 3 | 4 | 5 | 6 | 7 | 8 | 9 |
| 3/8 | 0.14 | 0.20 | 0.27 | #N/A | 0.12 | 0.06 | 0.07 | 0.05 |
| 1/2 | 0.20 | 0.29 | 0.34 | 0.08 | 0.18 | 0.07 | 0.10 | 0.06 |
| 5/8 | #N/A | 0.36 | 0.42 | #N/A | #N/A | 0.10 | #N/A | 0.08 |
| 3/4 | 0.33 | 0.46 | 0.64 | 0.14 | 0.24 | 0.15 | 0.14 | 0.11 |
| 1 | 0.47 | 0.66 | 0.84 | 0.23 | 0.35 | 0.23 | 0.23 | 0.17 |
| 1 1/4 | 0.68 | 0.88 | 1.04 | 0.35 | 0.48 | 0.39 | 0.38 | 0.26 |
| 1 1/2 | 0.94 | 1.14 | 1.36 | 0.49 | 0.57 | 0.55 | 0.55 | 0.36 |
| 2 | 1.46 | 1.75 | 2.06 | 0.83 | 0.76 | 0.92 | 0.91 | 0.61 |

| Empty pipe heat capacity Btu/ft.F | | | | | | | | |
|-----------------------------------|----------|----------|----------|-----------------|-------------|------------|----------|---------------|
| Nominal diameter [in] | Copper M | Copper L | Copper K | CPVC CTS SDR 11 | CPVC SCH 40 | PEX-AL-PEX | PE-AL-PE | PEX CTS SDR 9 |
| | 2 | 3 | 4 | 5 | 6 | 7 | 8 | 9 |
| 3/8 | 0.01 | 0.02 | 0.02 | #N/A | 0.02 | 0.04 | 0.04 | 0.02 |
| 1/2 | 0.02 | 0.03 | 0.03 | 0.02 | 0.04 | 0.04 | 0.06 | 0.03 |
| 5/8 | #N/A | 0.03 | 0.04 | #N/A | #N/A | 0.06 | #N/A | 0.05 |
| 3/4 | 0.03 | 0.04 | 0.06 | 0.03 | 0.05 | 0.08 | 0.08 | 0.06 |
| 1 | 0.04 | 0.06 | 0.08 | 0.05 | 0.07 | 0.13 | 0.13 | 0.09 |
| 1 1/4 | 0.06 | 0.08 | 0.09 | 0.07 | 0.10 | 0.21 | 0.21 | 0.14 |
| 1 1/2 | 0.08 | 0.10 | 0.12 | 0.10 | 0.11 | 0.30 | 0.30 | 0.20 |
| 2 | 0.13 | 0.16 | 0.19 | 0.17 | 0.15 | 0.50 | 0.50 | 0.34 |

| Pipe + water heat capacity Btu/ft.F | | | | | | | | |
|-------------------------------------|----------|----------|----------|-----------------|-------------|------------|----------|---------------|
| Nominal diameter [in] | Copper M | Copper L | Copper K | CPVC CTS SDR 11 | CPVC SCH 40 | PEX-AL-PEX | PE-AL-PE | PEX CTS SDR 9 |
| | 2 | 3 | 4 | 5 | 6 | 7 | 8 | 9 |
| 3/8 | 0.08 | 0.08 | 0.08 | #N/A | 0.11 | 0.08 | 0.08 | 0.07 |
| 1/2 | 0.13 | 0.13 | 0.13 | 0.10 | 0.17 | 0.12 | 0.14 | 0.11 |
| 5/8 | #N/A | 0.18 | 0.18 | #N/A | #N/A | 0.19 | #N/A | 0.16 |
| 3/4 | 0.25 | 0.25 | 0.25 | 0.20 | 0.28 | 0.30 | 0.30 | 0.22 |
| 1 | 0.42 | 0.42 | 0.41 | 0.33 | 0.44 | 0.49 | 0.49 | 0.35 |
| 1 1/4 | 0.63 | 0.62 | 0.62 | 0.50 | 0.74 | 0.76 | 0.76 | 0.53 |
| 1 1/2 | 0.87 | 0.87 | 0.87 | 0.70 | 0.99 | 1.20 | 1.20 | 0.74 |
| 2 | 1.50 | 1.49 | 1.49 | 1.19 | 1.60 | 1.90 | 1.89 | 1.26 |

N-2 Median ENERGY STAR Appliances (expanded)

| Appliance | Category One | Description One | Energy Use (kWh/yr) | MEF | Capacity (cu ft) | |
|-----------------|----------------------------|-------------------|---------------------|------|------------------|-----|
| Clothes Washer | Residential | Front Load | 105 | 3.28 | 4.5 | |
| | | Top Load | 157 | 2.46 | 4.8 | |
| Freezer | Compact | Manual Defrost | 219 | - | 3.9 | |
| | | Automatic Defrost | 356 | - | 4.6 | |
| | Upright | Manual Defrost | 247 | - | 8.5 | |
| | | Automatic Defrost | 438 | - | 13.8 | |
| | Chest | Manual Defrost | 220 | - | 10.8 | |
| Refrigerator | Compact | - | 230 | - | <7.75 | |
| | | Ice-Maker | 442 | - | | |
| | Top Freezer | - | 310 | - | <15 | |
| | | Ice-Maker | 416 | - | | |
| | | - | 362 | - | 15-20 | |
| | | Ice-Maker | 443 | - | | |
| | | - | 396 | - | >20 | |
| | | Ice-Maker | 475 | - | | |
| | Bottom Freezer | - | 381 | - | <15 | |
| | | Ice-Maker | 481 | - | | |
| | | - | 458 | - | 15-20 | |
| | | Ice-Maker | 551 | - | | |
| | | - | 490 | - | >20 | |
| | | Ice-Maker | 645 | - | | |
| | Side-by-Side | Ice-Maker | 583 | - | 15-20 | |
| | | | 644 | - | >20 | |
| | Freezer less & Single Door | Automatic Defrost | Manual Defrost | 209 | - | <15 |
| | | | 264 | - | <15 | |
| | | | 293 | - | 15-20 | |
| | | | 353 | - | >20 | |
| Upright Freezer | | 279 | - | <15 | | |

N-3 Minimum Interior Surface Temperature for Thermally Bridged Construction Details

One requirement for certification pertains to avoiding mold growth on interior surfaces caused by thermal bridges. Even if a thermal bridge is tolerable in terms of its impact on the space conditioning loads and demands, it is not tolerable if it can lead to mold growth on the inside.

If a thermal bridge is significant enough, Phius may ask that an interior surface mold risk analysis be completed according to ISO 13788. The calculator can be downloaded from the [Resource Library](#) page on the Phius website.

The detail is modeled in THERM, the same tool we use to calculate the *energy* impact of a thermal bridge. Instead of calculating the extra energy loss, the critical result is the point of lowest temperature on the inside surface, and the criterion is that at that point, the interior air, when chilled down to that temperature, should be at less than 80% relative humidity.

In addition to surfaces directly exposed to interior air, the requirement applies to interstitial surfaces that are a) inboard of the water control layer and b) adjacent to air gaps or air-permeable insulation (e.g. rim joist.) The requirement applies regardless of whether such a surface is inboard or outboard of the air barrier control layer.

Exception: the requirement does not apply if such an interstitial surface is separated/isolated from the interior air by a class I vapor retarder (e.g., air-permeable insulation fully encapsulated.)

The calculator, based on ISO 13788, outlines the appropriate boundary conditions to use in the THERM model – the outside temperature and the indoor relative humidity. This is based on consideration of the monthly average outside temperature and humidity for the climate. The outdoor humidity is added to an indoor source that depends on one of five building humidity classes from low to high.

For each month, a psychrometric calculation is then done to determine a minimum inside surface temperature needed to keep the RH at the surface below 80%.

The critical month is the one in which that minimum surface temperature is farthest from the outside temperature and closest to the inside temperature, because that requires the detail to be the most “insulating.” This “surface temperature factor” (fRsi) of the building element is defined mathematically as:

$$fRsi = \frac{(Inside\ surface\ temp - Outside\ temp)}{(Inside\ temp - Outside\ temp)}$$

with a surface resistance at the inside surface of Rsi.

(Usually, the critical month is also the coldest month - but not always. Depending on the climate it might be in October, for example.)

N-4 Window Comfort

The optimization used to set space conditioning targets allowed for code-minimum windows in the mid-rise and high-rise buildings. While the relaxed window performance may be most cost effective from an up-front cost and energy savings payback, it does not provide an adequate guardrail on ensuring comfort.

The whole-window U-value must be low enough such that the window surface inside is no more than a certain temperature difference (ΔT) lower than the inside air temperature when the outside air temp T_d is at the ASHRAE 99% design temperature. Window U-value as a design decision is more impactful to prevent discomfort during the heating season while shading devices, low-e coatings and solar heat gain coefficient (SHGC) are more impactful to prevent discomfort during the cooling season.⁶⁸

Maximum temperature difference (ΔT) =

6.0 °F for double-height spaces ($\geq 16'$);

14.7°F – (0.742 x HHS(ft)) for window head-height-from-sill HHS of 10 feet or less,

or 13.3°F, whichever is less;

where the whole-window U is calculated as:

$$U = \frac{\Delta T}{[R_{si}(T_{air,inside} - T_d)]}$$

$$R_{si} = 0.74 \frac{hrft^2\text{°F}}{BTU}$$

$$T_{air,inside} = 68\text{°F}$$

$$T_d = \text{ASHRAE 99\% Design Temperature } \text{°F (ASHRAE Fundamentals 2017)}$$

[The Phius Window Comfort & Condensation Risk Assessment Tool](#) performs the calculation noted above.

Exceptions:

1. Windows and doors in non 'regularly occupied' areas.

Example: a college dormitory with an entry lobby and no seating, exterior doors and windows to a vestibule, or a hallway in a school with only transient occupants.

2. ADA doors.

⁶⁸ The Efficient Windows Collaborative provides an easy-to-understand explanation of this concept here: [Control Comfort - Efficient Windows Collaborative](#)

3. For windows and non-ADA doors greater than 6' in height review rules below and review [Section I-1.3](#).
 1. Where window comfort cannot be met through the performance U-value, providing active heat at the perimeter may be used to meet the comfort criteria.
 2. The location of the perimeter heating is an important consideration and must be located within 3 feet in plan (1 meter) of the window.
 3. Perimeter heating may be provided from two distinct sources:
 - Primary heat source
 - Supplementary heat source
 - Using supplementary perimeter heating will impact the source energy and may be calculated as follows.
 - Calculate a heat demand (Btu): $(U\text{-proposed} - U\text{-criterion}) \times \text{Window Area (sf)} \times \text{HDD65} \times 24\text{h/day} = \text{Heating Demand Comfort (Btu)}$
 - Heating Demand Comfort divided by site efficiency of the supplemental heating system e.g. 100% for electric resistance or 80% for gas/hydronic.
 - Apply the correct source energy factor based on the fuel type.
 - Account for the additional energy use under System > Distribution > Supportive device / auxiliary energy. The device type should be set to 'Other' and the Energy demand should be input in watts with the Period of operation set to 1 khr/yr.

N-5 Recirculation Defrost

For ventilation units that can maintain the required fresh air ventilation rates on average with the unit intermittently in recirculation mode, then re-circulation defrost is acceptable. The unit needs to have enough boost to maintain the same time-average fresh air ventilation rate as it would at higher temperatures.

In the case that the cycle time is more than 3 hours. The ASHRAE 62.2-2010 Table 4.2 effectiveness factor calculation should be used to determine the required boost intermittent rate.

- See this article:
<https://homes.lbl.gov/ventilate-right/intermittent-ventilation-run-cycles>

$$\text{Intermittent fan flow rate} = \frac{\text{continuous fan flow rate}}{(\text{effectiveness factor } \varepsilon) \times (\text{fractional on-time } f)}$$

where:

continuous fan flow rate = **Required whole-building ventilation rate** for the house or apartment if the system was operated continuously

f = **Fractional on-time** for whole-building ventilation, or the percentage of time the whole-building ventilation equipment will operate in one duty cycle (the length of one complete on/off cycle).

ε = [Ventilation Effectiveness for Intermittent Fans](#) from Table 4.2 in ASHRAE Standard 62.2. **Note:** Table 4.2 is different in ASHRAE 62.2-2007 and ASHRAE 62.2-2010.

N-6 Non-Residential Building Process Loads

ASHRAE 90.1-2010 Process Energy Definition: Energy consumed in support of a manufacturing, industrial, or commercial process other than conditioning spaces and maintaining comfort and amenities for the occupants of a building.

- Process load allowances only apply to the source energy limit. They do not influence the space conditioning limits.
- The source energy allowance may include the energy use from an increased space conditioning load caused by that process load.
 - For example: A commercial kitchen requiring direct exhaust range hoods. The source energy allowance is calculated as a combination of the increased heating energy consumption caused by the exhaust and makeup air and the fan energy associated with operating the range hoods.
- Custom optimization targets may be used when process loads influence the space conditioning so much that they no longer fit within the typical internal gain profiles used during Phius' target setting optimization study. Review [Section 1.5.4](#) for more information.

N-7 Prescriptive Path

N-7.1 Compactness Criteria

The compactness requirement is intended not to force an ideal or optimal level of compactness, but rather to prevent particularly non-compact designs. The enclosure area AE must not exceed that of a notional rectangular building with the proposed interior conditioned floor area $iCFA$ and number of walkable levels N_s , calculated as follows:

$$AE \leq AEmax = 2 * (w * d + d * h + w * h)$$

$$\text{The height } h = H_s * N_s$$

$$\text{The depth } d = \frac{\frac{iCFA}{N_s}}{w - 0.6m} + 0.6m$$

$$\text{The width } w = \text{sqrt}\left(awd * \frac{iCFA}{N_s}\right) + 2 \text{ feet } (0.6m)$$

$$\text{The width to depth aspect ratio } awd = 3$$

$$\text{The height per story } H_s = 12 \text{ feet } (3.7m)$$

N-7.2 Solar Protection Criteria

Glazed fenestration solar heat gain coefficient: Requirements vary by climate zone and align with DOE Zero Energy Ready Home.

Fixed overhangs: Required for south windows in hot climate zones, with a depth that depends on the latitude and window height.

N-7.2.1 Fenestration Orientation (for detached houses only)

There are two rules pertaining to fenestration orientation, that is, the distribution of windows and glazed doors facing different directions.

1. Limit high peaks in cooling load in summer and shoulder seasons.
2. Limit net heat loss from the windows in winter.

These rules should not conflict because the “summer” rule concerns mostly east-west balance and the “winter” rule concerns mostly north-south balance, but it is possible to violate both, in some climate zones.

N-7.2.1.1 For Cooling

The fenestration orientation rule limiting cooling load peaks is based on the concept of adequate exposure diversity (AED) from ACCA Manual J. The idea is that the peak hour solar gain should not exceed the average over the daytime hours by more than a certain percentage. There are three compliance paths:

1. The most straightforward path is that, per Manual J Appendix 3, a dwelling is considered to have AED if “the total area of the windows, glass doors, and skylight assemblies does not exceed 15% of the associated floor area.”
2. The most involved path is to calculate AED, which requires software qualified for Manual J, and meet its criterion that the peak is no more than 30% over the average.
3. The middle path is to meet a simplified AED criterion developed for Phius CORE Prescriptive that varies by climate zone. The required inputs for simplified AED are the glazed fenestration areas facing the cardinal directions (North, East, South, and West). All windows are to be assigned to the nearest cardinal direction. The checklist calculates a score and compares it to the zone’s criterion.

The simplified AED score and criteria were derived from a computer experiment on a study building, using various fenestration orientation configurations in a representative city for each climate zone. The studied configurations comprised combinations of concentration and direction of concentration but with identical overall window area, e.g., 25% all around, 100% on one side, 50% on two sides, 33% on three sides. There are 15 such combinations x 19 zones, OA to 8, for a total of 285 study cases. The study buildings were configured at the window SHGC limits and with south overhangs, as required for the climate zone by those other rules. Hourly simulations were done in EnergyPlus and the ratio of peak hour solar transmission to the day average (ST Pk/Av) was then averaged over 4 weeks around the summer solstice plus 4 weeks around the autumnal equinox.

The general patterns that emerged were:

1. A balance of east- and west-facing areas was good.
2. High concentration in one direction was bad, unless it was north, though all-south was not too bad.

Regression formulas were fitted, zone by zone, to the ST Pk/Av Jun+Sep data as functions of the orientation configuration variables (fraction facing each direction). The correlation coefficients of the fits fell between 0.85 and 0.95. The criteria thresholds were set relative to each zone, at the level of the mean over the 15 configurations. That was usually ST Pk/Av ~ 1.9, i.e., a peak hour about 90% over the day average. The score calculated in the checklist is the predicted ST Pk/Av from the regression function for the specified window configuration, rescaled to a percentage of the way towards the zone limit. This levels the passing criterion to $\leq 100\%$ for all zones (lower is better).⁶⁹

⁶⁹ An attempt was made to find a correlation between this simplified AED and Manual J AED, by calculating both on a subset of 30 of the 285 study cases, but this did not work - the correlation coefficient was only 0.4. This may be due to differences in the Manual J design-day data compared to the TMY type weather data used to develop the simplified AED, or other Manual J AED calculation details we are not aware of as of this writing.

N-7.2.1.2 For Heating

The fenestration orientation rule for winter is based on the idea that the windows should preferably be oriented to have a net gain over the worst-case month (coldest/dimmest), or at least not too great a net loss. The same model buildings and representative cities were used as for the simplified AED cooling load study. The heat transmission loss from the windows was calculated with the windows at the U-value limit for the zone.

The results indicated that in zones 4C, 5C, and 8, net heat gain in the worst month was not possible with any window orientation, thus there is no orientation requirement for these zones. Also, in zones 0-3 the “winter” gain is either unavoidable, or again mostly unavailable due to the cooling season solar protection measures in place as required, thus there is no orientation requirement for zones 0-3.

For zones 4-7 except C, winter gain is desirable and fenestration orientation did make a big difference, so criteria were set: Regression functions of the orientation variables were fitted to the worst-month net heat gain data. The correlation coefficients of the fits were all over 0.98. The general pattern was that some North windows are tolerable if there are south-facing ones to compensate. The criteria thresholds were set relative to each zone, at the level of the median net gain over the 15 orientation configurations. The score calculated in the checklist is the difference between the predicted net gain from the regression function for the specified window orientation configuration, minus the zone target, then rescaled by the range of net gain over all the study cases. This makes for a leveled net gain score in the range of about ± 100 , where zero is passing and higher is better.

The “summer” and “winter” orientation rules were tested together with the compactness rule on 33 certified projects and some randomly generated fenestration orientations and they appeared to give good guidance.⁷⁰

N-7.3 Thermal Enclosure

The maximum U-value for fenestration is derived from the idea of maintaining the inside surface temperature high enough to prevent cold air from pooling under the window and causing an uncomfortable draft at ankle level. This uses the same formula in the PHIUS window comfort calculator (found in the [Resource Library](#)), evaluated at a window height of 10 feet and at the ASHRAE 99% outside design temperature.

The R-value requirements for the main assemblies (wall, roof, floor) are set using climate-dependent regression formulas fitted to the characteristics of the small houses, typical sized houses, and townhomes that were optimized in the 2018 standard-setting study, along

⁷⁰ The original idea was to have uniform criteria on the raw metrics, e.g. net gain > 0 for winter and ST Pk/Av Jun+Sep < 1.XX for summer, but the zone-to-zone differences were large enough that testing suggested zone-by-zone criteria would be a better idea. As noted above, the final scoring methods shift all zones to a uniform “ ≤ 1 ” and “ ≥ 0 ” basis

with the tiny-home cases studied for 2021. The formulas are continuous functions of climate location parameters such as heating-degree days and design heating temperatures. The marginal electricity price (taken on a state average basis) also has an influence, with more insulation being justifiable at higher prices. Enclosure tradeoffs can be made using the alternative path where the total thermal transmittance (ΣUA) of the building thermal envelope is less than or equal to the ΣUA if the individual component requirements were applied. See [Phius Standard Setting Document](#) for details.

N-7.4 Mechanical Ventilation

N-7.4.1 Recovery Effectiveness

A minimum sensible recovery efficiency in heating mode is calculated as the efficiency needed to deliver supply air at 60°F or warmer, without post-heating, at the average outside temperature of the coldest month in the climate location. (The device rating adjustment takes credit for passive heat gain from the fan motors, in heating mode.)

A minimum total recovery efficiency in cooling mode (latent + sensible) is set based on the climate zone, as shown in the table below. The required levels were set from consideration of both the range of available performance and the statistics of dehumidification degree-days zone-by-zone over 1,000 climate locations.

There is also a maximum length imposed on the ducts between the ventilation recovery device and the enclosure, which is tied to the size of the building as indicated by its floor area and number of stories – notionally half the short side of the building if it was a rectangle of aspect ratio 1.6.

| Cooling Mode | Climate Zone | | | |
|---------------------------------|--------------|---------|-----|--------|
| | 0A – 3A | 3B – 3C | 4A | 4B - 8 |
| Total Recovery Efficiency (TRE) | 60% | NR | 50% | NR |

N-7.4.2 Fan Efficiency

A limit on ventilation fan power was set based on the DOE ZERH Reference Home. The base limit is 0.83 [W/cfm] or (1.2 [cfm/W]) on mechanical fresh air ventilation systems. A tradeoff path is allowed for fresh air ventilation system efficiency and is built into the Phius CORE Prescriptive checklist. This tradeoff works in tandem with the Lighting, Appliances & Water Heating tradeoffs.

N-7.5 Mechanical Systems

For air-source heat pumps, the required efficiency goes by climate zone. Energy Star Most Efficient 2020 applies for CZ 0-3, 4C, and 5C. Other zones 4-8 must meet NEEP cold climate air-source heat pump v3.0 criteria.

For ground-source heat pumps, the requirement is tied to Energy Star Most Efficient 2020 criteria – it varies by equipment type but not by climate.

| Zone Requirements | Air Source Heat Pump | Ground Source Heat Pump |
|-------------------------------|---|-----------------------------------|
| Climate Zones 0-3C, 4C, 5C | HSPF \geq 9.6 SEER \geq 18 | COP \geq 3.1 EER \geq 16.1 |
| Climate Zones 4A-B, 5A-B, 6-8 | COP @ 5°F \geq 1.75 SEER \geq 15 | |

N-7.6 Lighting, Appliances & Water Heating

N-7.6.1 Lighting

Lighting is regulated by setting a minimum fixture efficacy of 83 lumens/watt for all fixtures. The alternate option is that the average efficacy of installed fixtures, weighted based on wattage, is equal to or greater than 83 lumens/watt.

Lighting is part of the equipment performance tradeoff path, and in that case, lamp efficacy can be lower if the overall annual energy budget for equipment is not exceeded. The annual energy use for the proposed building is calculated based on rated wattage of all fixtures installed and predetermined daily run times per fixture based on the room in which it is installed. The reference building annual lighting energy is calculated using the total lumens installed in the proposed building, applying the minimum efficacy of 83 lumens/watt to that lighting design to determine reference wattage per fixture, and using the same daily run times per fixture as the proposed building.

N-7.6.2 Appliances

Limits on individual appliance efficiencies were set based on either the top quartile of ENERGY STAR or ENERGY STAR Most Efficient 2020 appliance ratings. Project designs can meet each of these requirements individually or take the performance tradeoff path in which these ratings are used for the 'reference' efficiency.

N-7.6.3 Water Heating

Water heating energy is regulated with two main requirements:

1. The water heater must be installed in conditioned space, with a few exceptions based on annual average ambient temperature.
2. The water heater must meet or exceed the specified reference efficiency based on the type of water heater – heat pump or solar with electric backup.

N-7.6.4 Performance Tradeoff Calculation

In the performance tradeoff for builder-installed appliances, lighting, and water heating, the reference energy allowances for the regulated items are calculated as shown in the table below. The rationale for including items on the list is that they are:

1. Rated by Energy Star and
2. Typically, builder-installed as opposed to resident-installed.

For each item there is a reference level of efficiency for the equipment, and an embedded assumption about how much it is used. Together these factors determine the contribution of each item to the pooled energy allowance for builder-installed equipment. For ceiling fans and pool pumps, an amenity level is deduced from Building America benchmarks for annual energy use with ENERGY STAR Most Efficient 2020 device efficiency.

| Item | Efficiency Unit | Reference Efficiency | Reference Site kWh/yr |
|--|--------------------|----------------------|---|
| Clothes washers | LER (kWh/yr) | 135 | # planned * LER |
| Clothes dryers, electric | CEF | 3.93 | # occupants * (283/4.5)/CEF * 8.45 |
| Dishwashers | LER (kWh/yr) | 239 | # planned * LER |
| Refrigerators | LER (kWh/yr) | 315 | " |
| Freezers | LER (kWh/yr) | 450 | " |
| Ceiling Fans | cfm/W | 220.1 | # planned * 84.1 kWh/yr |
| Pool pumps | WEF (kgal/kWh) | 9.3 | # planned * 158.5 kWh/yr |
| Ventilation System (E/HRV) | W/cfm | 0.83 | 0.83 W/cfm * 8760 * ASHRAE 62.2 airflow (cfm) |
| Light fixtures | Lumens/Watt (lm/W) | 83 | # installed lumens / 83 lm/W * annual runtime per fixture |
| Electric vehicle chargers | Standby Power (W) | 1.81 | # planned * Standby power * 8760/1000 |
| Smart home energy management system (thermostat) | Standby Power (W) | 0.17 | " |
| Water Heating | UEF or SEF | 1.975 | # occupants * amenity ⁷¹ / 1.975 |

LER = label energy rating

SEF = solar energy factor

UEF = uniform energy factor

WEF = weighted energy factor

⁷¹ Amenity = 6.6 gal/person.day at 90F temperature rise * 1.25 operational waste factor, in kWh/person.yr.

N-8 Blinds

If the shading reduction factor for a blind in the closed position is “z”, and “Z effective” is in the input in WUFI Passive then:

For exterior blinds use:

$$Z \text{ effective} = 0.3 + 0.7 * z$$

Example: If blinds allow 46% solar access (solar transmittance, Ts) when closed, use that for z, and z effective turns out to be 62%.

$$Z \text{ effective} = 0.3 + (0.7*0.46) = 0.622$$

For interior blinds use:

$$Z \text{ effective} = 1 - (1-z) * (1-0.6)$$

Example: If blinds allow 46% solar access (solar transmittance, Ts) when closed, use that for z, and z effective turns out to be 78%.

$$Z \text{ effective} = 1 - (1-0.46) * (1-0.6) = 0.784$$

N-9 Multi-unit Lighting & MEL calculations

The basic protocol for lighting and miscellaneous electric loads is that they are calculated at 80% of RESNET (2013) levels for the “Rated Home”. [72] RESNET’s formulas are intended to apply to living/dwelling units, whether detached or attached, and strictly speaking to buildings of three stories or less. RESNET does not yet have protocol for multifamily common spaces. For Phius certification, the scope of the RESNET formulas is expanded to include multifamily buildings four stories or more in height but applies only to the dwelling units. Supplemental protocol for multifamily common spaces and certain outdoor loads follows Building America House Simulation Protocols (2014). [73] In the formulas, iCFA is used in place of RESNET’s CFA and Building America’s FFA. The RESNET lighting formulas have been expressed more compactly here but are algebraically equivalent to the published versions. There are additional options for calculating the energy use of pools and elevators.

Miscellaneous Electric Loads (MELs)

For whole-building certification:

$$MEL = MEL_{DWELL} + MEL_{COMM} + MEL_{YARD} \text{ (kWh/yr)}$$

MEL_{DWELL} accounts for the living units.

⁷² RESNET, op.cit., Section 303.4.

⁷³ Wilson, E. et al. 2014 *Building America House Simulation Protocols* (BAHSP). Golden, CO: National Renewable Energy Laboratory, 2014. Print..

<http://energy.gov/eere/buildings/house-simulation-protocols-report>

MEL_{COMM} accounts for the common spaces (if the design includes any).

MEL_{YARD} accounts for Large / Uncommon Electric and Gas loads (if the design includes any).

To facilitate verification, the MEL_{DWELL} calculation must be itemized. This may be done by unit type or floor-by-floor.

For itemization by unit type k :

$$MEL_{DWELL} = \sum_k units_k * (413 + 69 * Nbr_k + 0.91 * iCFA_k) * 0.8$$

k are the unit types.

$units_k$ is the number of units of type k in the building.

Nbr_k is the number of bedrooms in a unit of type k .

$iCFA_k$ is the interior conditioned floor area of a unit of type k . [74]

For purposes of this calculation, $iCFA_k$ may include or exclude the projected floor area of interior partition walls within or between units, whichever approach is simpler to document.

For itemization by floor n :

$$MEL_{DWELL} = \sum_n (units_n * 413 + 69 * Nbr_n + 0.91 * iCFA_{DWELL,n}) * 0.8$$

n are the floors.

$units_n$ is the number of units on floor n .

Nbr_n is the number of bedrooms on floor n .

$iCFA_{DWELL,n}$ is the interior conditioned floor area of all the dwelling units on floor n , including the partition walls within and between units, but not including the floor area of the common spaces.

For purposes of this calculation, $iCFA_{DWELL,n}$ may include or exclude the projected floor area of interior partition walls to common spaces, whichever approach is simpler to document.

For MEL_{COMM} add the following, or submit a more detailed accounting.

⁷⁴ RESNET, op. cit., clause 303.4.1.7.2.1 "Residual MELs" and 303.4.1.7.2.6 "Televisions".

Multifamily Common Space MELs ^[75]

| Room Type | Electricity (kWh/yr) |
|----------------------------------|----------------------|
| Office | 3.2 x iCFA |
| Workout room | 9.8 x iCFA |
| Corridor / Restroom / Mechanical | 0 |
| Elevator | *Varies |

*Aligned with [Energy Star Multifamily New Construction Simulation Guidelines Version 1 \(Rev. 01\)](#) Section 3.11.3. This calculation is built into the [Phius Multifamily Lighting & Misc Load Calculator](#).

Alternate for elevators: More detailed calculations may be made using the following resources.

<https://www.thyssenkruppelevator.com/Tools/energy-calculator>

<http://www.schindler3300na.com/cgi-bin/calc/calc.pl>

Although BAHSP has protocol for some “Multipurpose Room MELs”, in a whole-building model any television, dishwasher, range, or microwave in a multipurpose room may be neglected – usage of these in the multipurpose room is assumed to displace usage in the units. However, any refrigerators or freezers in a multipurpose room should be added as additional appliances at their rated kWh/day.

For MEL_{YARD} use the table below or perform a more detailed calculation.

Large Uncommon Electric and Gas Loads ^[76]

| Appliance | Electricity (kWh/yr) | Natural Gas (therms/yr) |
|--------------------------|--------------------------------|-------------------------------|
| Pool heater (gas) | - | $3/0.014 \times F_{scale}$ |
| Pool heater (electric) | $10.1/0.0044 \times F_{scale}$ | - |
| Pool pump | $158.5/0.07 \times F_{scale}$ | - |
| Hot tub/spa heater (gas) | - | $0.87/0.011 \times F_{scale}$ |

⁷⁵ BAHSP, op. cit., Table 25. For Office and Workout room, footnote therein refers in turn to “Home Energy Usage Chart,” Public Service of New Hampshire, 2013, and assumes 1h/wk usage.

⁷⁶ BAHSP, op. cit., Table 26.

| | | |
|--------------------------------------|---------------------|---------------------|
| Hot tub/spa heater (electric) | 49/0.048 × Fscale | - |
| Hot tub/spa pump | 59.5/0.059 × Fscale | - |
| Well pump | 50.8/0.127 × Fscale | - |
| Gas fireplace | - | 1.95/0.032 × Fscale |
| Gas grill | 0.87/0.029 × Fscale | - |
| Gas lighting | 0.22/0.012 × Fscale | - |

Where the scaling factor, $F_{scale} = (0.5 + 0.25 \text{ Nbr}/3 + 0.25 \text{ iCFA}/1920)$.

$$1 \text{ therm} = 100 \text{ kBtu} / [3.412 \text{ kBtu/kWh}] = 29.3 \text{ kWh}$$

IndoorPoolCalc, an online spreadsheet from the Washington State University Extension Energy Program, estimates the savings of several energy conservation measures for pools. Download the calculator and background information in the [Resource Library](#).

Lighting

The lighting formulas below refer to “qualifying” light fixtures or locations, which means high-efficacy lighting. For residential projects fluorescent hard-wired (i.e. pin-based) lamps with ballast, screw-in compact fluorescent bulb(s), LEDs,

$LIGHTS_{INT,DWELL}$ accounts for the living units. ^[77] or light fixtures controlled by a photocell and motion sensor, are all considered high-efficacy.

Interior Lighting

For whole-building certification:

$$LIGHTS_{INT} = LIGHTS_{INT,DWELL} + LIGHTS_{INT,COMM} \text{ (kWh/yr)}$$

$LIGHTS_{INT,COMM}$ accounts for the common spaces (if the design includes any).

As with MELs, the $LIGHTS_{INT,DWELL}$ calculation must be itemized. This may be done by unit type or floor-by-floor.

For itemization by unit type k :

$$LIGHTS_{INT,DWELL} = \sum_k \text{units}_k * (0.2 + 0.8 * (4 - 3 * qFFIL)/3.7) * (455 + 0.8 * iCFA_k) * 0.8$$

$qFFIL$ is the ratio of the qualifying interior light fixtures to all interior light fixtures in qualifying interior light fixture locations.

⁷⁷ RESNET, op. cit., clause 303.4.1.7.2.2 Interior Lighting, and equation 5.

For itemization by floor n :

$$LIGHTS_{INT,DWELL} =$$

$$\sum_n (0.2 + 0.8 * (4 - 3 * qFFIL)/3.7) * (units_n * 455 + 0.8 * iCFA_{DWELL,n}) * 0.8$$

For $LIGHTS_{INT,COMM}$ use the table below for any of the listed Room Types that are included in the design, or submit a more detailed calculation.

Multifamily Common Space Lighting [78]

| Room Type | Operating Hours (hrs/day) | LPD (W/ft ²) |
|------------------|---------------------------|--------------------------|
| Central Restroom | 1.6 | 0.9 |
| Common Laundry | 24 | 0.7 |
| Common Mail | 12 | 2.8 |
| Common Office | 9 | 1 |
| Elevator | 24 | 1.25 |
| Equipment Room | 0 | 1.5 |
| Indoor Corridor | 24 | 0.5 |
| Multi-Purpose | 12 | 1.1 |
| Workout Room | 16 | 0.9 |

$$LIGHTS_{INT,COMM} = (Operating\ hours * operating\ days * LPD * iCFA_{COMM})/1000$$

Operating hours are per day.

Operating days are per year.

LPD is the lighting power density of the space in W/ft².

$iCFA_{COMM}$ is the interior conditioned floor area of each unique common space, not including interior partition walls.

Occupancy Sensors: A 10% reduction in LPD is allowed for common spaces where occupancy

⁷⁸ Building America "B10 Analysis – New Construction 2011-01-26" workbook, Detailed Lighting tab, C89:D101 and C120:L132

sensors are documented in project submission (as in ASHRAE 90.1 Appendix G). Projects may also complete a custom calculation for reduction in LPD in corridors based on occupancy sensors, using Phius MF Interior Corridor Lighting Occupancy Sensor Calculator, downloadable from the [Resource Library](#).

When applying the reduction factor to stairwells in buildings that also have elevators, project teams may assume as low as a 50% of the traffic is by stairs in residential buildings.

Exterior Lighting

$$LIGHS_{EXT} = LIGHS_{EXT,DWELL} + LIGHS_{EXT,COMM} + LIGHS_{GAR} \text{ (kWh/yr)}$$

$LIGHS_{EXT,DWELL}$ pertains to exterior lighting for the dwelling units (balcony/porch or general building lights). [79]

$LIGHS_{EXT,COMM}$ pertains to exterior lighting for the common spaces (exterior courtyards, exterior corridors/stairs, outdoor walkways, etc.)

$LIGHS_{GAR}$ pertains only if the project includes a garage.*

For itemization by unit type k :

$$LIGHS_{EXT,DWELL} = \sum_k units_k * (1 - 0.75 * FFEL) * (100 + 0.05 * iCFA_k) * 0.8$$

$FFEL$ is the fraction of exterior fixtures that are qualifying light fixtures.

For itemization by floor n :

$$LIGHS_{EXT,DWELL} = \sum_n (1 - 0.75 * FFEL) * (units_n * 100 + 0.05 * iCFA_n) * 0.8$$

For $LIGHS_{EXT,COMM}$ use the table below for any of the listed Room Types that are included in the design, or submit a more detailed calculation.

⁷⁹ RESNET, op. cit., clause 303.4.1.7.2.3 Exterior Lighting, and equation 6.

Exterior Lighting ^[80]

| Room Type | Operating Hours (hrs/day) | (W/ft ²) |
|------------------|---------------------------|----------------------|
| Open Parking* | 12 | 0.15 |
| Outdoor Stairs | 12 | 0.3 |
| Outdoor Walkways | 12 | 0.3 |

$$LIGHTS_{EXT,COMM} = (Operating\ hours * operating\ days * LPD * iCFA_{COMM}) / 1000$$

Operating hours are per day. *Operating days* are per year.

LPD is the lighting power density of the space in W/ft².

iCFA_{COMM} is the interior conditioned floor area of each unique common space, not including interior partition walls.

Garage lighting may be calculated by the “80% RESNET” formula ^[81], BA default, or a more detailed calculation.

$$LIGHTS_{GAR} = Units * 100 * (1 - 0.75 * FFGL) * 0.8$$

Units is the total number of dwelling units in the building

FFGL is the fraction of garage fixtures that are Qualifying Light Fixtures.

Garage Lighting* ^[82]

| Room Type | Operating Hours (hrs/day) | W/ft ² |
|-----------------|---------------------------|-------------------|
| Parking Garage* | 24 | 0.2 |

*Note: Phius does not require projects to include lighting energy for an open parking lot / parking garage, block heaters, or vehicle charging in the energy model for certification. For now, these are considered to be part of the “transportation sector” as opposed to the “building sector”.

⁸⁰ B10 Analysis workbook, op. cit.

⁸¹ RESNET, op. cit., clause 303.4.1.7.2.4 Garage lighting, and equation 7.

⁸² B10 Analysis workbook, op. cit.

N-10 Non-Residential Utilization Patterns

Standard Default Patterns (per DIN V 18599-10:2007-02, Table 4) for Internal Loads and Occupancy Calculations for Non-Residential Buildings

| SPACE TYPE | BEGINNING OF USAGE (TIME) | END OF USAGE (TIME) | ANNUAL UTILIZATION DAYS (d/a) | MAINTAINED ILLUMINANCE (lux) | HEIGHT OF THE WORK PLANE (ft) | RELATIVE ABSENTEEISM | FACTOR FOR LIGHTING RELATIVE TO BUILDING OPERATION TIME |
|---|---------------------------|---------------------|-------------------------------|------------------------------|-------------------------------|----------------------|---|
| Garage buildings (for offices and private use) | 7:00 | 18:00 | 250 | 75 | 0 | 0.95 | 1 |
| Garage buildings (public use) | 9:00 | 0:00 | 365 | 75 | 0 | 0.8 | 1 |
| Traffic /circulation areas | 7:00 | 18:00 | 250 | 100 | 0 | 0.8 | 1 |
| Auxiliary spaces (without habitable rooms) | 7:00 | 18:00 | 250 | 100 | 2.6 | 0.9 | 1 |
| Storeroom, technical equipment room,archive | 7:00 | 18:00 | 250 | 100 | 2.6 | 0.98 | 1 |
| Library - magazine and stores | 8:00 | 20:00 | 300 | 100 | 2.6 | 0.9 | 1 |
| Booking hall | 7:00 | 18:00 | 250 | 200 | 2.6 | 0 | 1 |
| Hotel bedroom | 21:00 | 8:00 | 365 | 200 | 2.6 | 0.25 | 0.3 |
| Canteen | 8:00 | 15:00 | 250 | 200 | 2.6 | 0 | 1 |
| Restaurant | 10:00 | 0:00 | 300 | 200 | 2.6 | 0 | 1 |
| Toilets and sanitary facilities in non residential buildings | 7:00 | 18:00 | 250 | 200 | 2.6 | 0.9 | 1 |
| Spectators and audience area (theaters and event locations) | 19:00 | 23:00 | 250 | 200 | 2.6 | 0 | 1 |
| Exhibition rooms and museums with conservation requirements | 10:00 | 18:00 | 250 | 200 | 2.6 | 0 | 1 |
| Library-open stacks areas | 8:00 | 20:00 | 300 | 200 | 2.6 | 0 | 1 |
| Retail shop/Department store | 8:00 | 20:00 | 300 | 300 | 2.6 | 0 | 1 |
| Retail shop/department store (food department with refrigerated products) | 8:00 | 20:00 | 300 | 300 | 2.6 | 0 | 1 |
| Classroom (school and nursery school) | 8:00 | 15:00 | 200 | 300 | 2.6 | 0.25 | 0.9 |
| Hospital ward or dormitory | 0:00 | 24:00 | 365 | 300 | 2.6 | 0 | 0.5 |
| Kitchen - preparation room or storeroom | 7:00 | 23:00 | 300 | 300 | 2.6 | 0.5 | 1 |
| Other Habitable Room | 7:00 | 18:00 | 250 | 300 | 2.6 | 0.5 | 1 |
| Foyer (theaters and event locations) | 19:00 | 23:00 | 250 | 300 | 2.6 | 0.5 | 1 |
| Fair/Congress building | 13:00 | 18:00 | 150 | 300 | 2.6 | 0.5 | 1 |
| Sports hall (without public viewing area) | 8:00 | 23:00 | 300 | 300 | 2.6 | 0.3 | 1 |
| Personal office (single occupant) | 7:00 | 18:00 | 250 | 500 | 2.6 | 0.3 | 0.7 |
| Workgroup office (two to six workplaces) | 7:00 | 18:00 | 250 | 500 | 2.6 | 0.3 | 0.7 |
| Landscaped office (seven or more workplaces) | 7:00 | 18:00 | 250 | 500 | 2.6 | 0 | 1 |
| Meeting, conference and seminar room | 7:00 | 18:00 | 250 | 500 | 2.6 | 0.5 | 1 |
| Lecture room, auditorium | 8:00 | 18:00 | 150 | 500 | 2.6 | 0.25 | 0.7 |
| Kitchens in non-residential buildings | 10:00 | 23:00 | 300 | 500 | 2.6 | 0 | 1 |
| Server room, computer center | 0:00 | 24:00 | 365 | 500 | 2.6 | 0.5 | 0.5 |
| Workshop, assembly,manufacturing | 7:00 | 16:00 | 250 | 500 | 2.6 | 0 | 1 |
| Library - reading rooms | 8:00 | 20:00 | 300 | 500 | 2.6 | 0 | 1 |
| Stage (theaters and event locations) | 13:00 | 23:00 | 250 | 1000 | 2.6 | 0 | 0.6 |

N-11 Domestic Hot Water Design Requirements

N-11.1 DOE ZERH Requirements

Phius aligns with endnote 5 from the [DOE Zero Energy Ready Homes National Program Requirements \(Rev. 08\)](#) for the design of centralized domestic hot water (DHW) distribution systems in multifamily projects that are less than or equal to (\leq) 5 stories in height. Per ZERH:

- Centralized systems must include on-demand recirculation which operates based on both a demand indicator and the loop temperature.
 - Recirculation systems that employ “adaptive” or “learning” technologies comply with ZERH’s definition of a “demand indicator”.

Exception:

- Phius strongly discourages, but shall not prevent the use of continuous or time-based hot water circulation systems in multifamily buildings of 6 or more stories and in non-residential projects.

N-11.2 Definitions

Definitions from the ‘Hot Water Piping’ tab relevant to [Section 6.10.2](#).

- Demand Circulation: Checking this box resets the ‘up-stream volume’ for any branch connected to that trunk, i.e. it will assume the branch will always be served with hot water and the trunk length should not be considered when estimating the ‘time to hot’ for the EPA WaterSense Hot Water Delivery test.
 - The on-demand recirculation pipes must still be entered to accurately account for DHW pipe distribution losses, even though it resets the volume in the trunk for the ‘time to hot’ calculation.
- Pipe material: Update the pipe material as shown in the floor plans. The most common pipe types are Copper L and PEX-AL-PEX.
- Pipe diameter: This should be verifiable from the floor plans and input in WUFI Passive to match.
- Heat Capacity: This is calculated based on the type of piping chosen, piping diameter and piping length.
- Volume [oz]: The calculated total volume of water stored in this pipe based on the pipe material, piping diameter and piping length.
- Cumulative volume [oz]: This calculated volume is used to determine a project’s compliance with the Watersense. If ‘Demand recirculation’ is checked for a trunk, the cumulative volume of that pipe will be zeroed out and not count towards the volume of water stored in the pipe.
- Time to “hot” @ 1 gpm [s]: Calculates an estimate of how long it will take the water to rise 10F in seconds based on the cumulative volume of water in the pipes. 60 seconds coincides with failing the Watersense test.